

**MASTERMED**  
MASTERS EN PRODUCTOS MÉDICOS

# CATÁLOGO

## Instrumentos Quirúrgicos

Linea -K (Marca Krown)

Terminado Satinado

Certificado ISO 9002, CE, FDA



MASTERMED  
MASTERS EN PRODUCTOS MÉDICOS

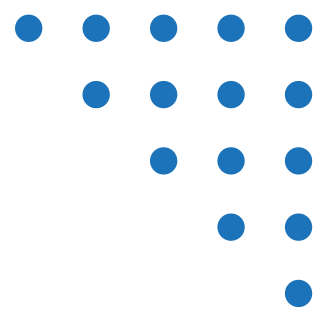

## TABLAS DE CONVERSIÓN DE MEDIDAS

INCHES TO CENTIMETERS		INCHES TO MILIMETERS	
	INCHES CM		INCHES MM
	0.5 1.27		0.5 12.70
	1 2.54		1 25.40
	1.5 3.81		1.5 38.10
	2 5.08		2 50.80
	2.5 6.35		2.5 63.50
	3 7.62		3 76.20
	3.5 8.89		3.5 88.90
	4 10.16		4 101.60
	4.5 11.43		4.5 114.30
	5 12.70		5 127.00
	5.5 13.97		5.5 139.70
	6 15.24		6 152.40
	6.5 16.51		6.5 165.10
	7 17.78		7 177.80
	7.5 19.05		7.5 190.50
	8 20.32		8 203.20
	8.5 21.59		8.5 215.90
	9 22.86		9 228.60
	9.5 24.13		9.5 241.30
	10 25.40		10 254.00
	10.5 26.67		10.5 266.70
	11 27.94		11 279.40
	11.5 29.21		11.5 292.10
	12 30.48		12 304.80
	12.5 31.75		12.5 317.50
	13 33.02		13 330.20
	13.5 34.29		13.5 342.90
	14 35.56		14 355.60
	14.5 36.83		14.5 368.30
	15 38.10		15 381.00



## TABLA DE CONTENIDO

Instrumentos Para Diagnóstico .....	1, 2		
Instrumentos Para Anestesia .....	3, 5		
Instrumental Tonsila (Amigdalas) Y Oral .....	6, 7		
Mangos De Bisturí .....	8		
Tijeras Para Operaciones .....	9-17		
Tijeras Para Vendajes .....	18-21		
Tijeras Para Emplasto .....	22		
Tijeras Con Hojas De Tungsteno-Carburo (TC) .....	23-26		
Pinzas Hemostáticas .....	27-33		
Pinzas De Campos .....	34, 35		
Porta Esponjas .....	36-38		
Porta Agujas .....	39-43		
Porta Agujas De Tungsteno-Carburo (TC) .....	44, 45		
Pinzas De Disección Y Quirúrgicas .....	46-48		
Pinza Fina De Disección .....	49		
Pinzas Intestinales .....	50-52		
Sondas Acanaladas Y Estiletes .....	53		
Instrumento Tonsila .....	54		
Instrumental Nasal Y Para Oído .....	55-57		
Diapasones Neurológicos De Aluminio .....	58-60		
Espéculos Nasales .....	61, 62		
Cánulas - Tubos De Aspiración .....	63		
Separadores Generales .....	64-78		
Instrumentos Para Cálculos Biliares .....	79-82		
Instrumental Cardiovascular Atraumático .....	83-		
85 Instrumental Para Ginecología .....			
86-89 Pinzas Uterinas .....			
90-92	Cánula	Para	Biopsia
.....			93 Instrumental Para
Ginecología .....			94-97 Curetas Para
Ginecología Y Dilatadores .....			98-101 Pinzas Para
Histeroectomía .....			102, 103 Pinzas Para
Cálculos Biliares .....			104 Pinzas
Obstétricas .....			105-107



**MASTERMED**  
MASTERS EN PRODUCTOS MÉDICOS

Instrumental Para Vasectomía Sin Bisturí .....	108
Instrumental Rectal .....	109
Sierras Para Hueso Y Mango Con Sierras .....	110, 111
Mazos .....	112
Instrumentos Post Mortorios Y Ortopédicos .....	113
Laringoscopios .....	114-123
Equipo De Otoscopia .....	124, 125
Cepillos De Limpieza Para Cirujano .....	126
Hojas De Bisturí .....	127-129
Agujas Para Sutura .....	130-131
Productos Para Cuidado de Pacientes y Accesorios Para Hospitales .....	132-149
Sets De Instrumentos .....	150-156





MASTERMED  
MASTERS EN PRODUCTOS MÉDICOS

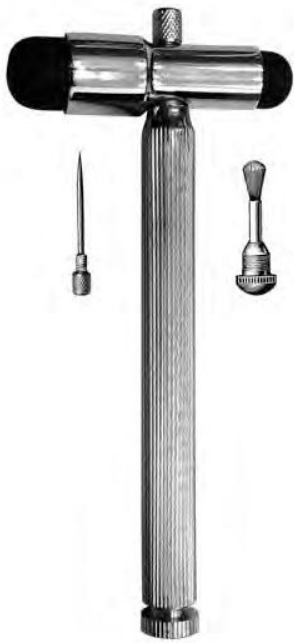
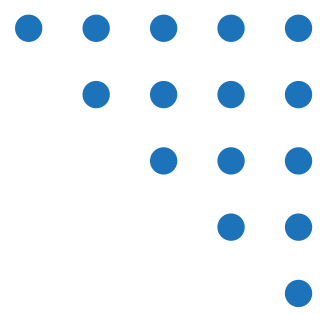

**K-02-460**



**K-02-461**



**K-02-463**

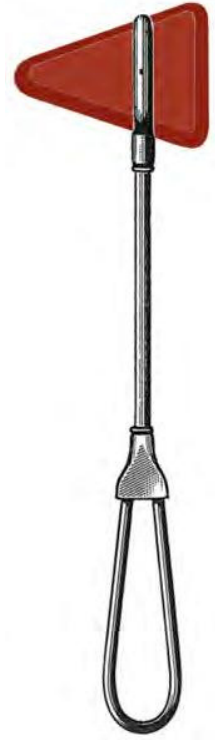

## INSTRUMENTOS PARA DIAGNÓSTICO

**K-02-460** Martillo Neurológico Telescopico, Cromado, 4½" x 7" (11.4 cm x 17.8 cm)

**K-02-461 K-** Martillo Neurológico BUCK, Cromado, 7¾" (19.7 cm)

**02-463 K-** Martillo TAYLOR, cromado, con gomas rojas, 7½" (19.1 cm)

**02-463-S** Martillo TAYLOR, acero inoxidable, con gomas rojas, 7½" (19.1 cm)





MASTERMED  
MASTERS EN PRODUCTOS MÉDICOS

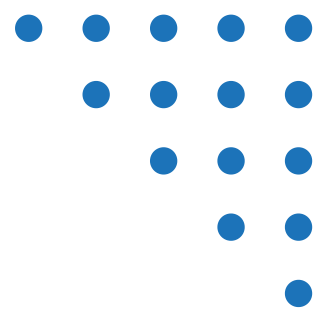

**K-02-467**  
**K-02-468**



**K-02-469**



**K-02-470**



**K-02-471**



**K-02-472**

## INSTRUMENTOS PARA DIAGNÓSTICO

- K-02-467** Martillo BABINSKI de Percusión con pin y tornillo, 8" (20.3 cm)  
**K-02-468** Martillo BABINSKI de Percusión con pin y tornillo, 10" (25.4 cm)
- K-02-469** Martillo DEJERINE de Percusión sin pin, 8" (20.3 cm)
- K-02-470** Martillo DEJERINE de Percusión con pin y tornillo, 8¼" (20.9 cm)
- K-02-471** Sensimetro WARTENBERG, con Molinete, 7" (17.8 cm)
- K-02-472** Cortador de Anillos para dedos, 6½" (16.5cm)





**MASTERMED**  
MASTERS EN PRODUCTOS MÉDICOS

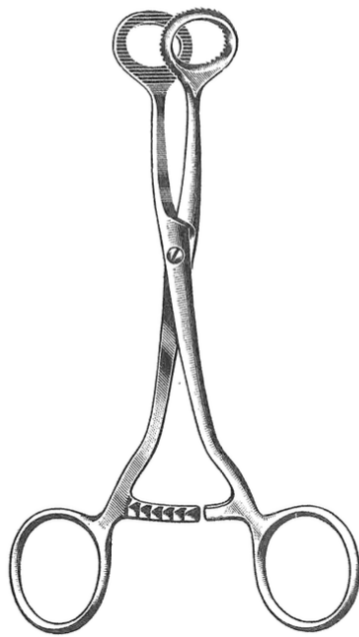
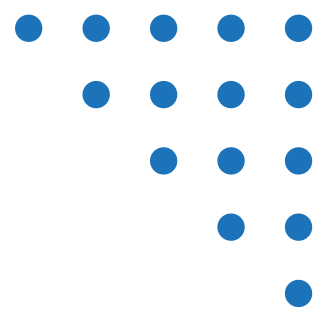

**K-02-442**

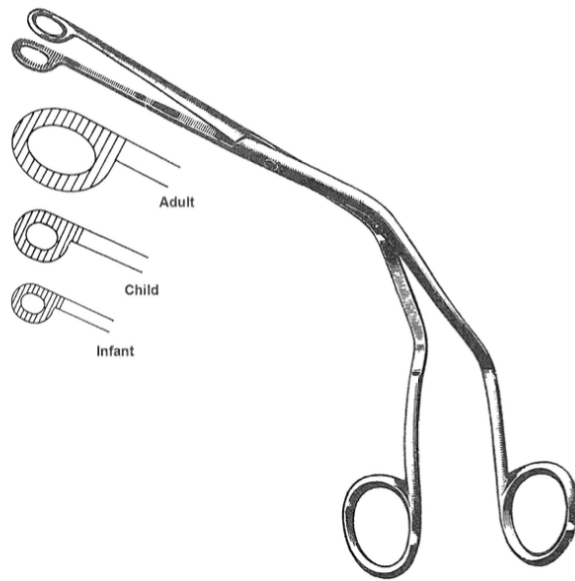

**K-02-445**  
**K-02-446**  
**K-02-447**

## INSTRUMENTOS PARA ANESTESIA

- K-02-442** Pinza Abre boca de COLLINS, Oval, 6¾" (17.1cm)
- K-02-445** Pinza de MAGILL, Tamaño, Pediátrico, 7" (17.8 cm)
- K-02-446** Pinza de MAGILL, para Niños, 8½" (21.6 cm)
- K-02-447** Pinza de MAGILL, para Adultos, 9¾" (24.8 cm)





MASTERMED  
MASTERS EN PRODUCTOS MÉDICOS

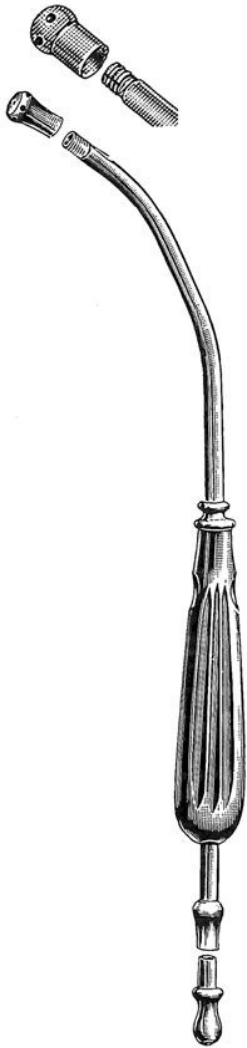
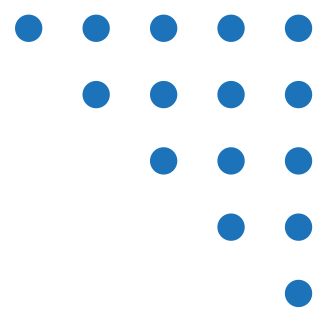

**K-02-448**



**K-02-451**



**K-02-452**

## INSTRUMENTOS PARA ANESTESIA

**K-02-448** Cánula Aspiradora de YANKAUER, Acero Inoxidable, 11<sup>3</sup>/<sub>4</sub>" (29.9 cm)

**K-02-451** Cánula de Succión POOL, Curva, 23 Fr., Cromada, 8<sup>3</sup>/<sub>4</sub>" (22.2 cm)

**K-02-452** Cánula de Succión POOL, Recta, 30 Fr., Acero Inoxidable, 8<sup>3</sup>/<sub>4</sub>" (22.2 cm)





**MASTERMED**  
MASTERS EN PRODUCTOS MÉDICOS

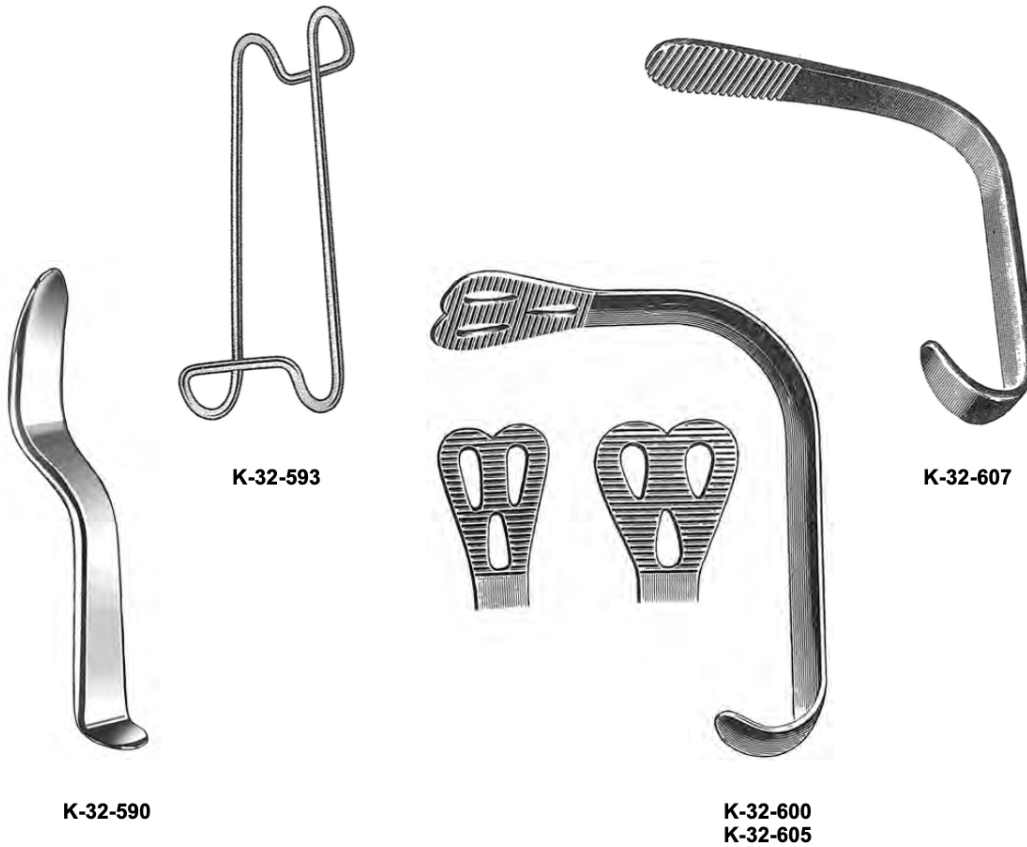

## INSTRUMENTOS PARA ANESTESIA

- K-32-590** Retractor de cachete UNIVERSIDAD DE MINNESOTA, Doble Punta, 5½" (14 cm)
- K-32-593** Retractor Labial COLUMBIA, Doble Punta, 35 mm x 50 mm, 5½" (14 cm)
- K-32-600** Depresor de Lengua WEIDER, Valva pequeña, 28 mm Dentada, 5½" (14 cm)
- K-32-605** Depresor de Lengua WEIDER, Valva grande, 36 mm Dentada, 6" (15.2 cm)
- K-32-607** Depresor de Lengua ANDREWS, 21 mm, Dentada, 4¼" (10.8 cm)



**K-32-573**



**K-32-575**



**K-32-580**

## INSTRUMENTAL TONSILA (AMIGDALAS) Y ORAL

- K-32-573** Abre-boca de DOYEN-JANSEN, Pediátrico, Con Seguro, 4" (10.2 cm)
- K-32-575** Abre-boca de DOYEN-JANSEN, para Niños, Con Seguro, 4½" (11.4 cm)
- K-32-580** Abre-boca de DOYEN-JANSEN, para Adultos, Con Seguro, 5½" (14 cm)





**MASTERMED**  
MASTERS EN PRODUCTOS MÉDICOS

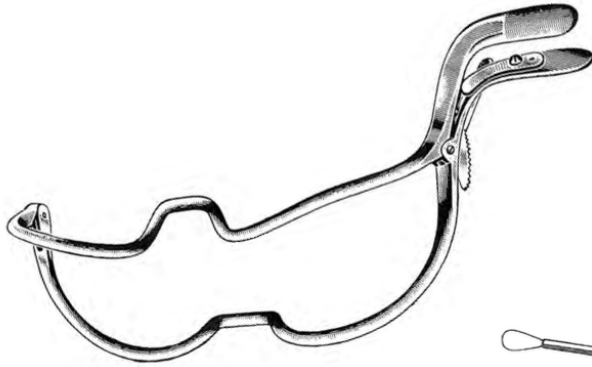

**K-32-582**  
**K-32-583**  
**K-32-584**

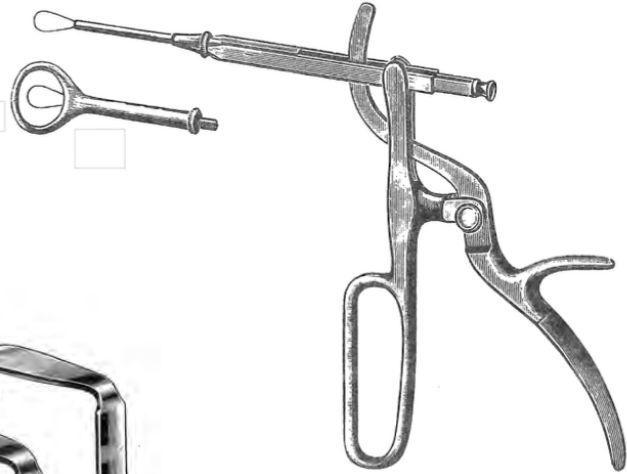

**K-32-592**



**K-32-585**

## INSTRUMENTAL TONSILA (AMIGDALAS) Y ORAL

- K-32-582** Abre-boca de JENNINGS, infante, Automática, 3¾" (9.5 cm)
- K-32-583** Abre-boca de JENNINGS, para Niños, Automática, 4¾" (12.1 cm)
- K-32-584** Abre-boca de JENNINGS, para Adultos, Automática, 6" (15.2 cm)
- K-32-585** Abre-boca MCIVOR, set con 3 valvas, 5¾" (14.6 cm)
- K-32-592** Instrumental Tonsila TYDING Snare, Completo con Punta Recta, 6⅝" (16.8 cm)



MASTERMED  
MASTERS EN PRODUCTOS MÉDICOS

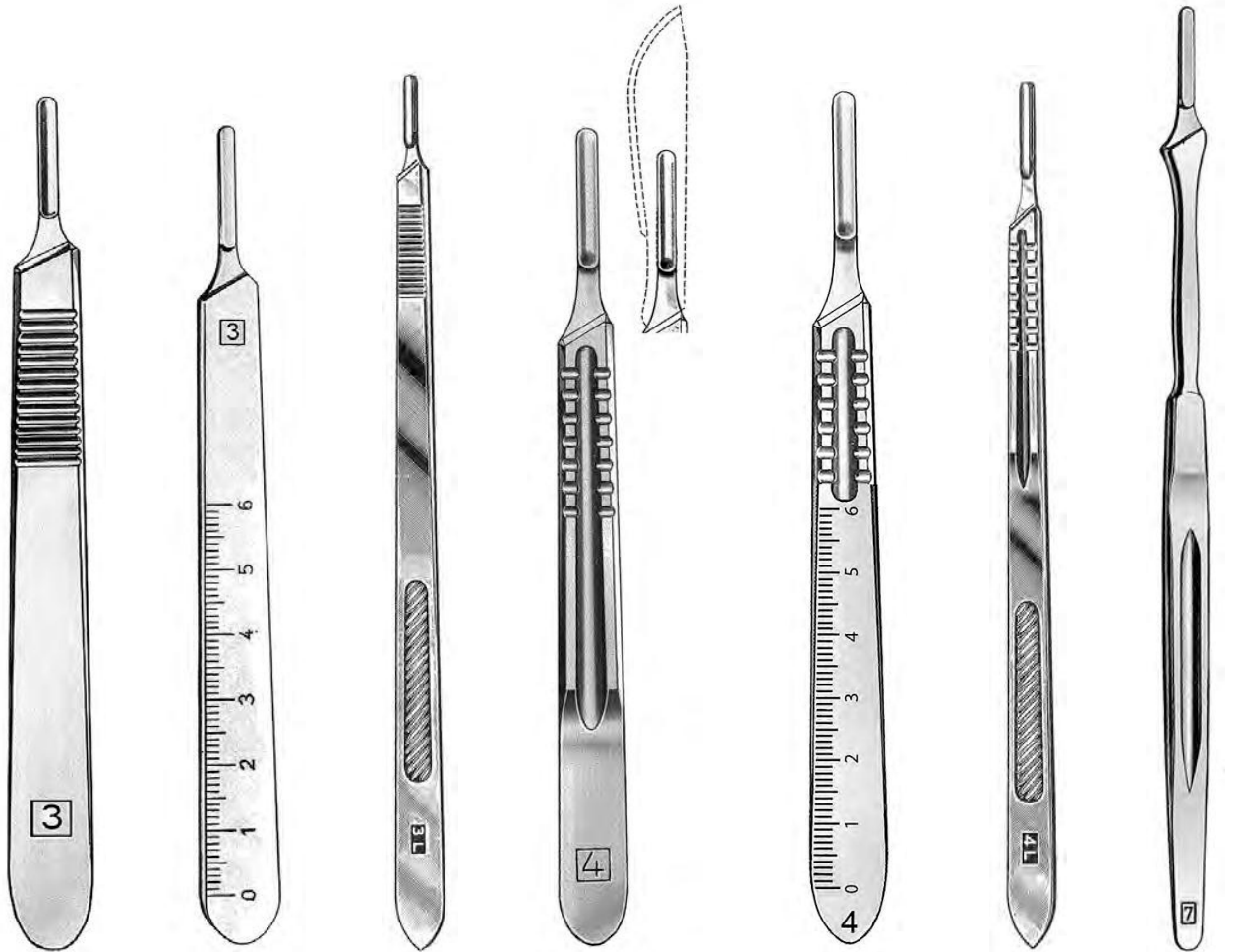

K-02-490

K-02-490-SC

K-02-491

K-02-492

K-02-492-SC

K-02-493

K-02-494

## MANGOS DE BISTURI

- K-02-490** Mango de Bisturí, No.3 (para hojas numero 10 al 15)
- K-02-490-SC** Mango de Bisturí, No.3 con escala (para hojas numero 10 al 15)
- K-02-491** Mango de Bisturí, No.3L (para hojas numero 10 al 15)
- K-02-492** Mango de Bisturí, No.4 (para hojas numero 20 al 25)
- K-02-492-SC** Mango de Bisturí, No.4 con escala (para hojas numero 20 al 25)
- K-02-493** Mango de Bisturí, No.4L (para hojas numero 20 al 25)
- K-02-494** Mango de Bisturí, No.7 (para hojas numero 10 al 15)



**MASTERMED**  
MASTERS EN PRODUCTOS MÉDICOS

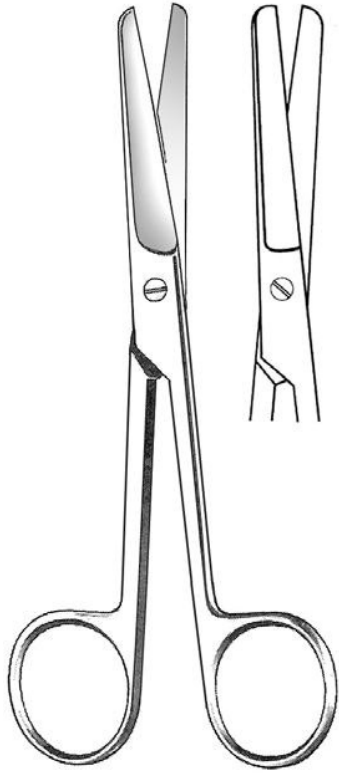
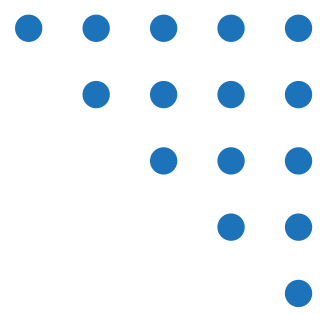

**K-11-107 B/B**  
**K-11-109 B/B**

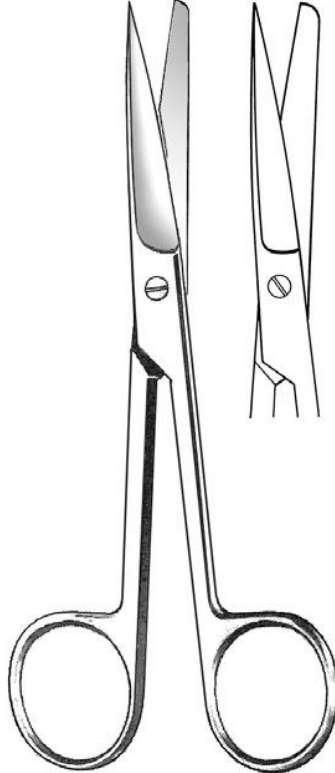

**K-11-107 S/B**  
**K-11-109 S/B**

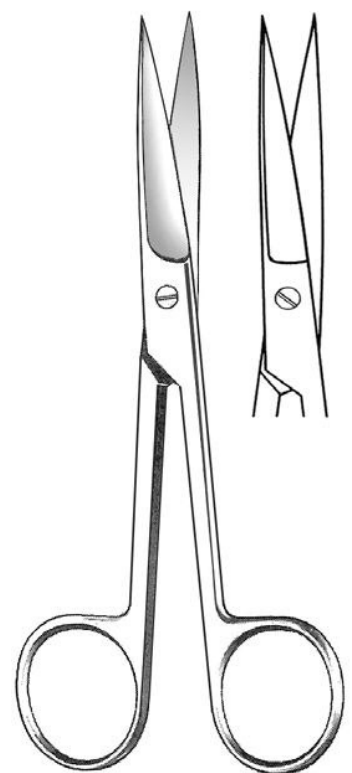

**K-11-107 S/S**

## TIJERAS PARA OPERACIONES

- K-11-107-B/B** Tijeras Quirúrgicas, Roma/Roma, Recta, 5½" (14 cm)
- K-11-107-S/B** Tijeras Quirúrgicas, Aguda/Roma, Recta, 5½" (14cm)
- K-11-107-S/S** Tijeras Quirúrgicas, Aguda/Aguda, Recta, 5½" (14 cm)
  
- K-11-109-B/B** Tijeras Quirúrgicas, Roma/Roma, Recta, 6½" (16.5 cm)
- K-11-109-S/B** Tijeras Quirúrgicas, Aguda/Roma, Recta, 6½" (16.5 cm)





**MASTERMED**  
MASTERS EN PRODUCTOS MÉDICOS

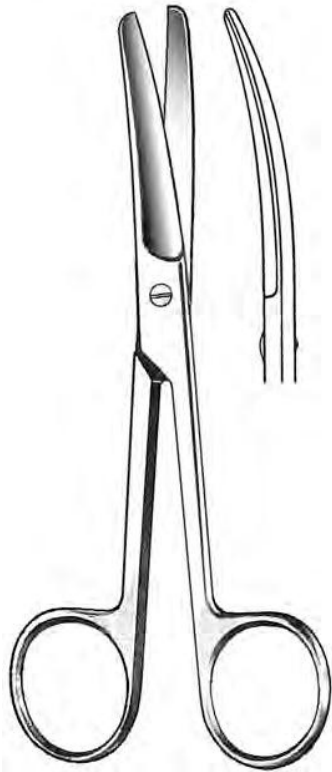
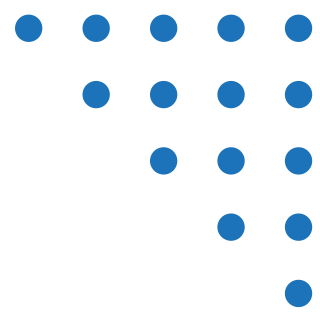

**K-11-108 B/B**

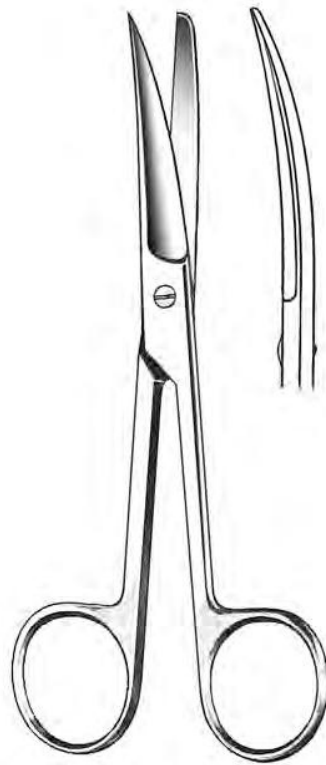

**K-11-108 S/B**  
**K-11-110 S/B**

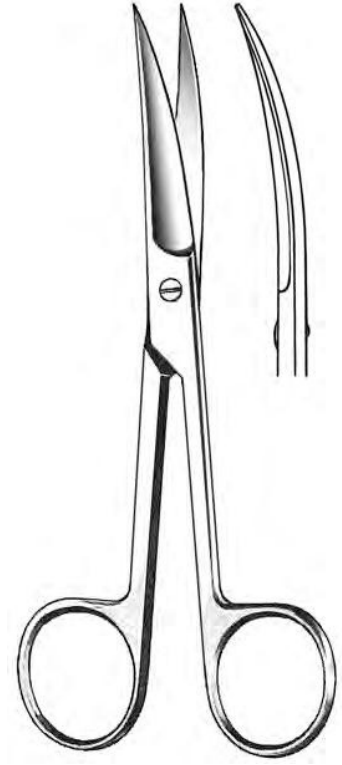

**K-11-108 S/S**

## TIJERAS PARA OPERACIONES

- K-11-108-B/B** Tijeras Quirúrgicas, Roma/Roma, Curva, 5½" (14 cm)
- K-11-108-S/B** Tijeras Quirúrgicas, Aguda/Roma, Curva, 5½" (14 cm)
- K-11-110-S/B** Tijeras Quirúrgicas, Aguda/Roma, Curva, 6½" (16.5 cm)
- K-11-108-S/S** Tijeras Quirúrgicas, Aguda/Aguda, Curva, 5½" (14 cm)





MASTERMED  
MASTERS EN PRODUCTOS MÉDICOS

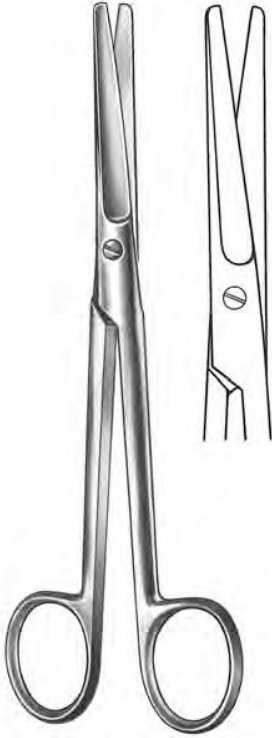
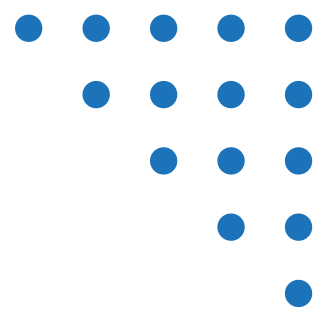

**K-11-115**  
**K-11-117**



**K-11-116**  
**K-11-118**



**K-11-119-A**



**K-11-119-B**

## TIJERAS PARA OPERACIONES

- K-11-115** Tijeras de Disección MAYO, Recta, 5½" (14 cm)
- K-11-116** Tijeras de Disección MAYO, Curva, 5½" (14 cm)
- K-11-117** Tijeras de Disección MAYO, Recta, 6¾" (17.1 cm)
- K-11-118** Tijeras de Disección MAYO, Curva, 6¾" (17.1 cm)
- K-11-119 -A** Tijeras de Disección MAYO, Recta, 9" (22.9 cm)
- K-11-119 -B** Tijeras de Disección MAYO, Curva, 9" (22.9 cm)





**MASTERMED**  
MASTERS EN PRODUCTOS MÉDICOS

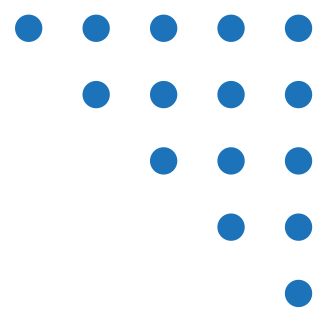

**K-11-119-D**

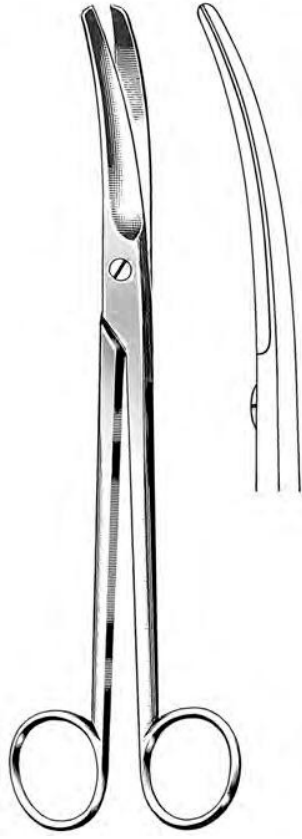

**K-11-119-E**

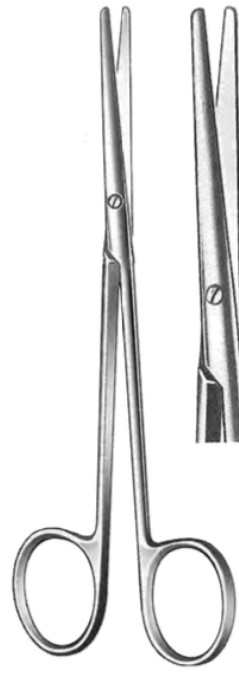

**K-11-120**



**K-11-121**

## TIJERAS PARA OPERACIONES

- K-11-119-D** Tijeras de Disección MAYO-HARRINGTO, Recta, Satinado, 11" (27.9 cm)
- K-11-119-E** Tijeras de Disección MAYO-Harrington, Curva, 11" (27.9 cm)
- K-11-120 K-** Tijeras METZENBAUM, Recta, 5¾" (14.6 cm)
- 11-121** Tijeras METZENBAUM, Curva, 5¾" (14.6 cm)



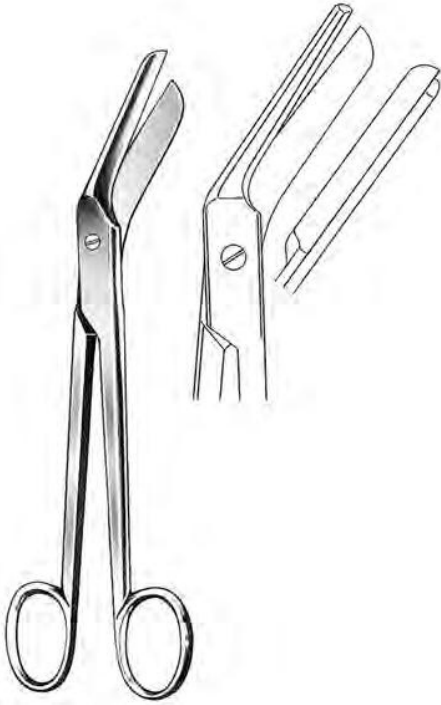
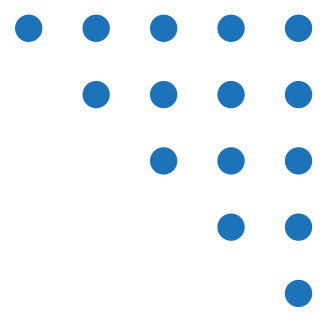

**K-11-147**

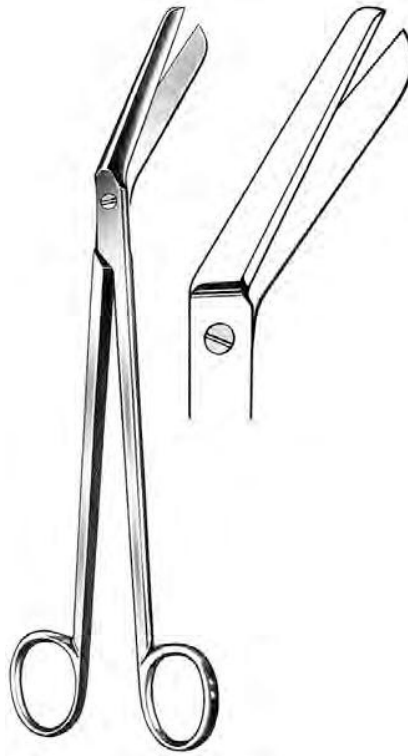

**K-11-147-A**



**K-11-148**

## TIJERAS PARA OPERACIONES

- K-11-147** Tijeras BRAUN de Episiotomía, Angulada, 5½" (14 cm)
- K-11-147-A** Tijeras BRAUN de Episiotomía, Angulada, 8½" (21.6 cm)
- K-11-148** Tijeras Modelo USA para Cordón Umbilical, 4" (10.2 cm)







**MASTERMED**  
MASTERS EN PRODUCTOS MÉDICOS

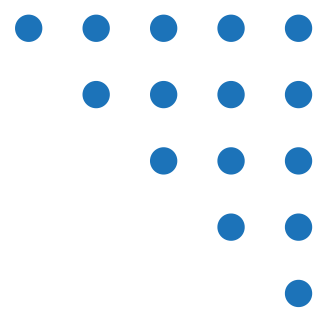

**K-11-153**

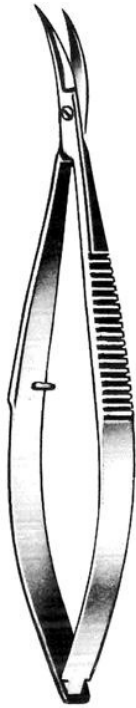

**K-11-154**



**K-11-155**

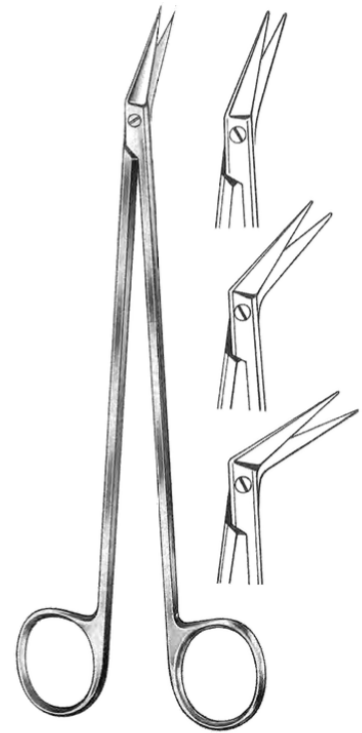

**K-11-155-A**  
**K-11-155-B**  
**K-11-155-C**

## TIJERAS PARA OPERACIONES

- K-11-153** Tijeras CASTROVIEJO, Aguda/Aguda, Recta, 4¼" (10.8 cm)
- K-11-154** Tijeras CASTROVIEJO, Aguda/Aguda, Curva, 4¼" (10.8 cm)
- K-11-155** Tijeras CASTROVIEJO, Angulada, Aguda/Aguda, 4¼" (10.8 cm)
  
- K-11-155-A** Tijeras POTTS-SMITH, Angulada 25°, 7½" (19.1 cm)
- K-11-155-B** Tijeras POTTS-SMITH, Angulada 45°, 7½" (19.1 cm)
- K-11-155-C** Tijeras POTTS-SMITH, Angulada 60°, 7½" (19.1 cm)





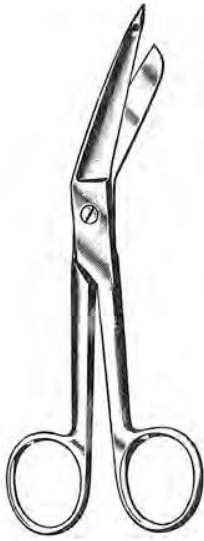
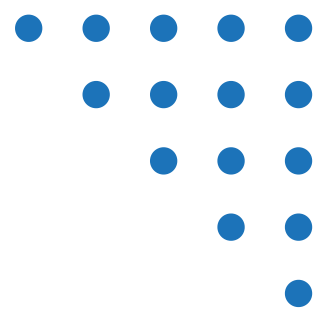

**K-11-157**



**K-11-158**



**K-11-159**

## TIJERAS PARA VENDAJES

- K-11-157** Tijeras LISTER, para Vendajes, 4½" (11.4 cm)
- K-11-158** Tijeras LISTER, para Vendajes, 5½" (14 cm)
- K-11-159** Tijeras LISTER, para Vendajes, 7½" (19.1 cm)



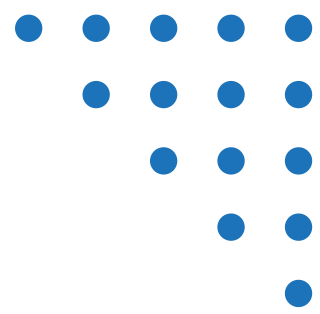

**K-11-176**



**K-11-177**

## TIJERAS PARA VENDAJE

**K-11-176** Tijeras UTILITY, (Uso general), Colores variados, 5½" (14 cm)

**K-11-177** Tijeras UTILITY, (Uso general), Colores variados, 7½" (19.1 cm)





MASTERMED  
MASTERS EN PRODUCTOS MÉDICOS

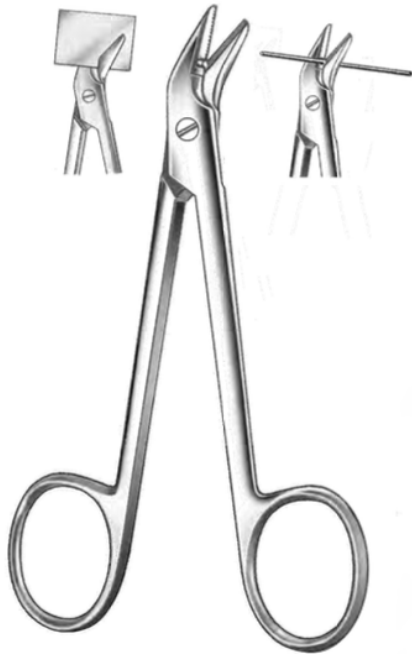
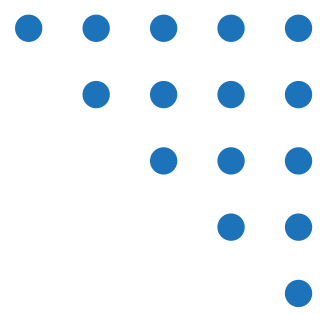

**K-11-178**



**K-11-180**

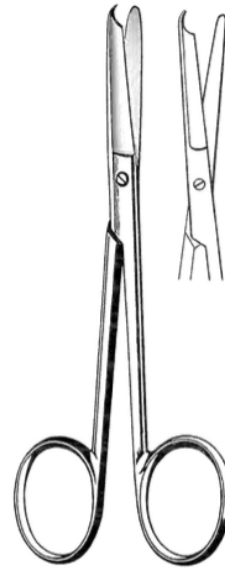

**K-11-181**



**K-11-182**

## TIJERAS PARA VENDAJE

- K-11-178** Tijeras ROGER, Para Cable, Angulada, 4 $\frac{3}{4}$ " (12.1 cm)
- K-11-180** Tijeras SPENCER, Para Quitar Puntos de Sutura, 3 $\frac{1}{2}$ " (8.9 cm)
- K-11-181** Tijeras LITTAUER, Para Quitar Puntos de Sutura, 4 $\frac{1}{2}$ " (11.4 cm)
- K-11-182** Tijeras LITTAUER, Para Quitar Puntos de Sutura, 5 $\frac{1}{2}$ " (14 cm)





**MASTERMED**  
MASTERS EN PRODUCTOS MÉDICOS

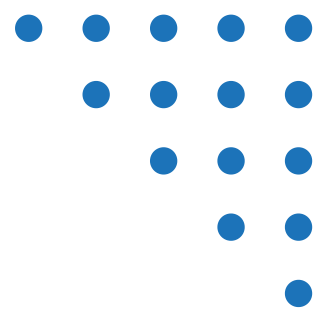

**K-11-186-A**



**K-11-186-B**



**K-11-188**

## TIJERAS PARA VENDAJE

- K-11-186-A** Tijeras WESTCOTT, Curva, 4½" (11.4 cm)
- K-11-186-B** Tijeras WESTCOTT, Recta, 4½" (11.4 cm)
- K-11-188** Tijeras CROWN AND COLLAR, Recta, Hojas Lisas, 4½" (11.4 cm)





**MASTERMED**  
MASTERS EN PRODUCTOS MÉDICOS

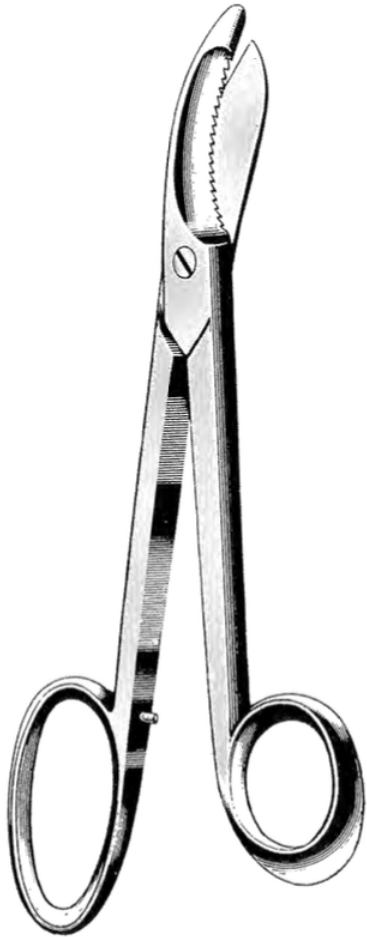
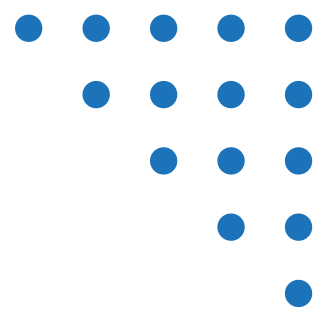

**K-30-887**

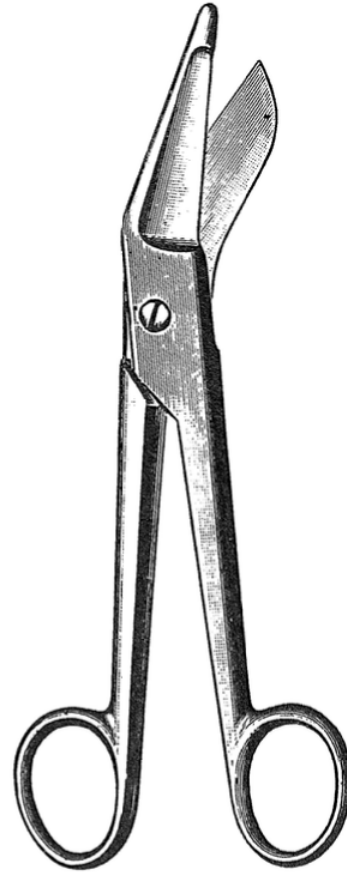

**K-30-888**

## TIJERAS PARA EMPLASTO

**K-30-887** Tijeras BRUNS, Para Emplasto, Satinado, 9¼" (23.5 cm)

**K-30-888** Tijeras ESMARCH, Para Emplasto, Satinado, 8" (20.3 cm)





**MASTERMED**  
MASTERS EN PRODUCTOS MÉDICOS

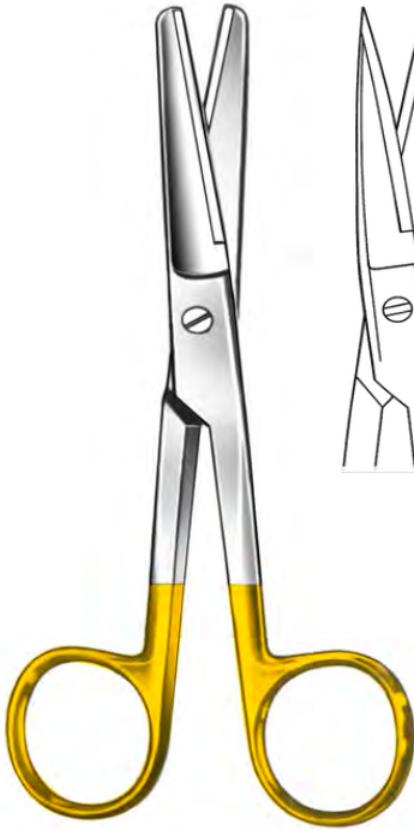
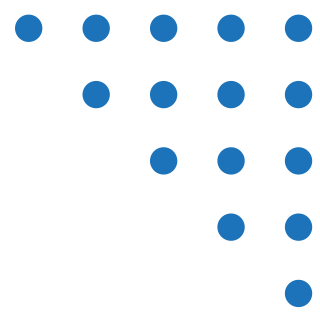

**K-16-800**

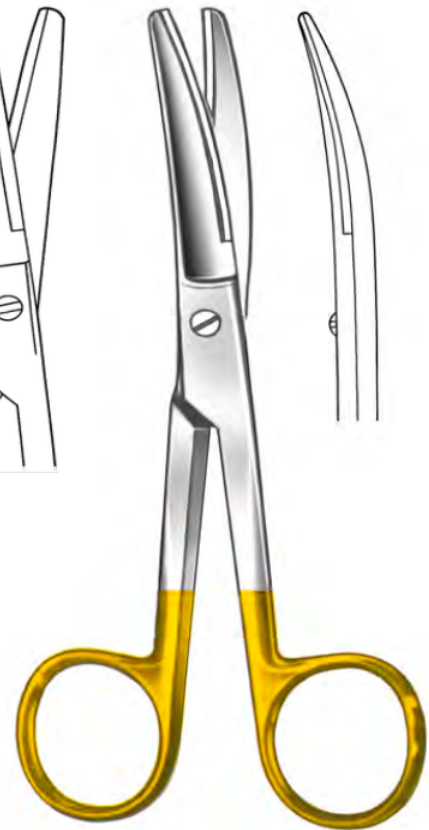

**K-16-802**



## TIJERAS CON HOJAS DE TUNGSTENO-CARBURO (TC)

**K-16-800** Tijeras Quirúrgicas, Aguda/Roma, Recta, TC, 5½" (14 cm)

**K-16-802** Tijeras Quirúrgicas, Aguda/Roma, Curva, TC, 5½" (14 cm)





**MASTERMED**  
MASTERS EN PRODUCTOS MÉDICOS

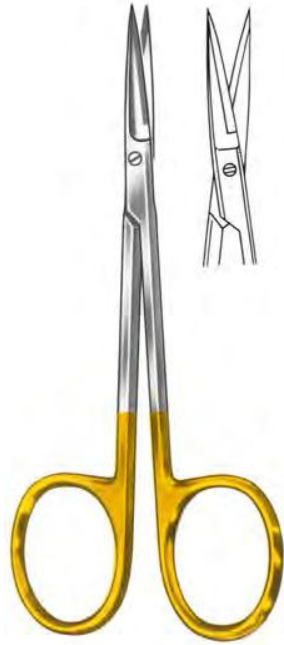
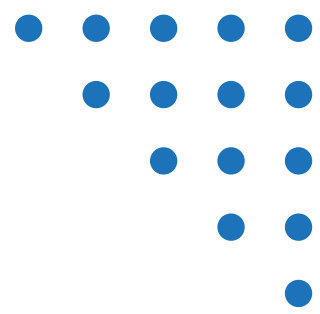

**K-16-826**

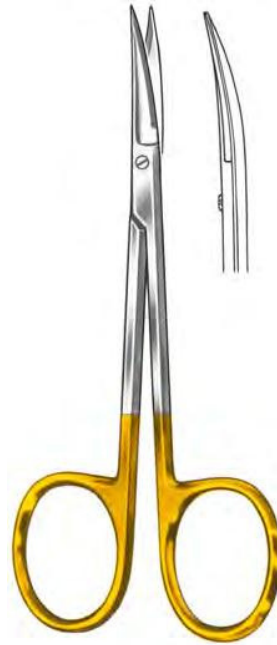

**K-16-830**

## TIJERAS CON HOJAS DE TUNGSTENO-CARBURO (TC)

**K-16-826** Tijeras IRIS, Recta, TC, 4½" (11.4 cm)

**K-16-830** Tijeras IRIS, Curva, TC, ½" (11.4 cm)





**MASTERMED**  
MASTERS EN PRODUCTOS MÉDICOS

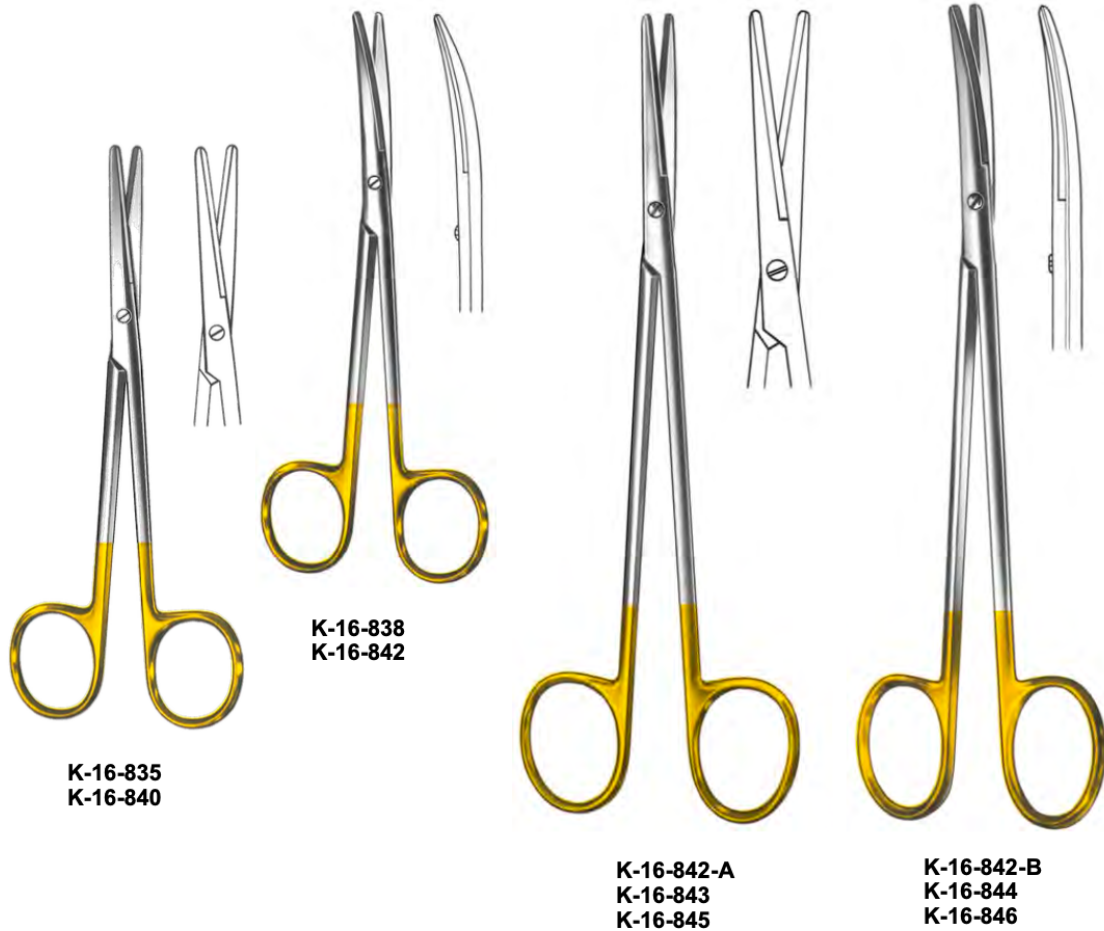

## TIJERAS DE DISECCIÓN Y QUIRÚRGICAS CON HOJAS DE TUNGSTENO-CARBURO (TC)

K-16-835	Tijeras METZENBAUM, Recta, TC, 5½" (14 cm)
K-16-838	Tijeras METZENBAUM, Curva, TC, 5½" (14 cm)
K-16-840	Tijeras METZENBAUM, Recta, TC, 7" (17.8 cm)
K-16-842	Tijeras METZENBAUM, Curva, TC, 7" (17.8 cm)
K-16-842-A	Tijeras METZENBAUM, Recta, TC, 8" (20.3 cm)
K-16-842-B	Tijeras METZENBAUM, Curva, TC, 8" (20.3 cm)
K-16-843	Tijeras METZENBAUM, Recta, TC, 9" (22.9 cm)
K-16-844	Tijeras METZENBAUM, Curva, TC, 9" (22.9 cm)
K-16-845	Tijeras METZENBAUM, Recta, TC, 10" (25.4 cm)
K-16-846	Tijeras METZENBAUM, Curva, TC, 10" (25.4 cm)





**MASTERMED**  
MASTERS EN PRODUCTOS MÉDICOS

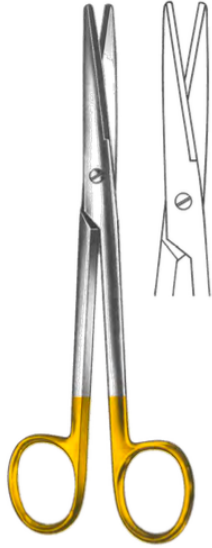

**K-16-851**  
**K-16-854**



**K-16-852**  
**K-16-856**

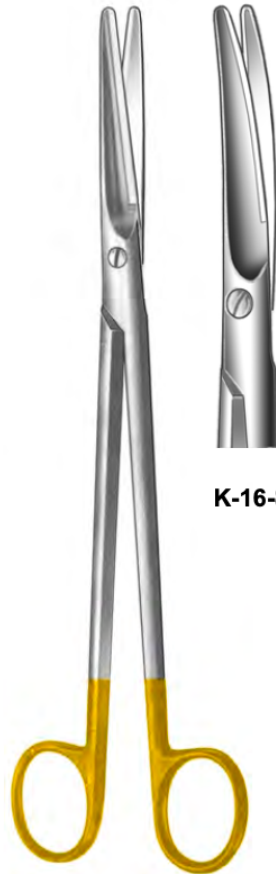

**K-16-858**

**K-16-860**

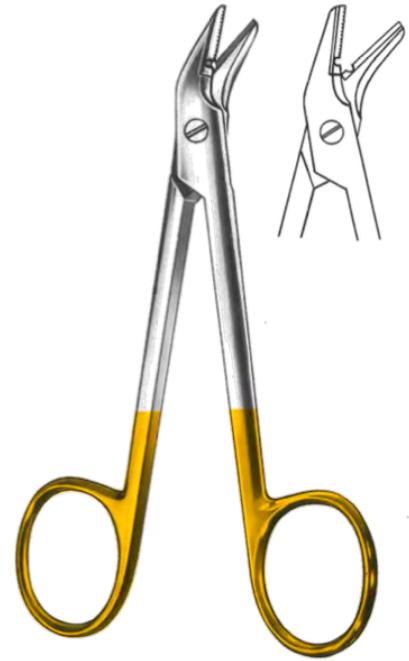

**K-16-870**

## TIJERAS CON HOJAS DE TUNGSTENO-CARBURO (TC)

- |                 |                                                       |
|-----------------|-------------------------------------------------------|
| <b>K-16-851</b> | Tijeras MAYO de Disección, Recta, TC, 5½" (14 cm)     |
| <b>K-16-852</b> | Tijeras MAYO de Disección, Curva, TC, 5½" (14 cm)     |
| <b>K-16-854</b> | Tijeras MAYO de Disección, Recta, TC, 6¾" (17.1 cm)   |
| <b>K-16-856</b> | Tijeras MAYO de Disección, Curva, TC, 6¾" (17.1 cm)   |
| <b>K-16-858</b> | Tijeras MAYO de Disección, Recta, TC, 9" (22.9 cm)    |
| <b>K-16-860</b> | Tijeras MAYO de Disección, Curva, TC, 9" (22.9 cm)    |
| <b>K-16-870</b> | Tijeras ROGER para Cable, Angulada, TC, 4¾" (12.1 cm) |



**MASTERMED**  
MASTERS EN PRODUCTOS MÉDICOS



**K-12-180**



**K-12-181**



**K-12-182**



**K-12-183**

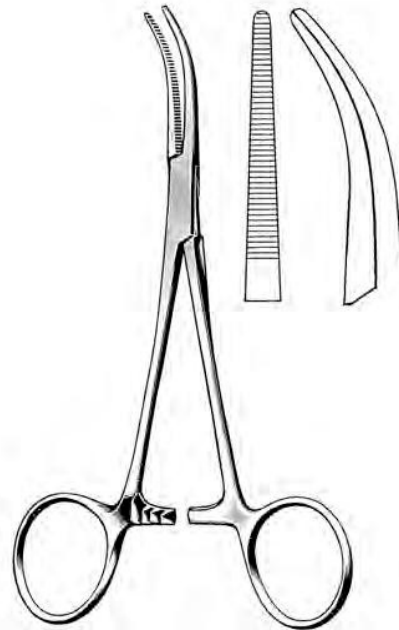

**K-12-187-D**

## PINZAS HEMOSTÁTICAS

- K-12-180** Pinza de HARTMAN, Mosquito, Recta, 3½" (8.9 cm)
- K-12-181** Pinza de HARTMAN, Mosquito, Curva, 3½" (8.9 cm)
- K-12-182** Pinza de HALSTEAD, Mosquito, Recta, 5" (12.7 cm)
- K-12-183** Pinza de HALSTEAD, Mosquito, Curva, 5" (12.7 cm)
- K-12-187-D** Pinza de DANDY, Curva de lado, 5½" (14 cm)



**MASTERMED**  
MASTERS EN PRODUCTOS MÉDICOS

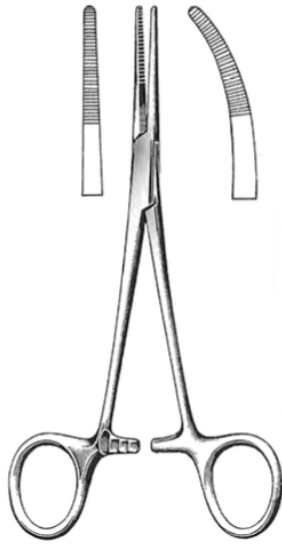

**K-12-188**  
**K-12-189**

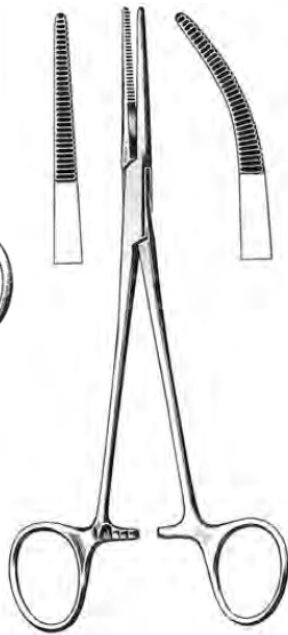

**K-12-190**  
**K-12-191**

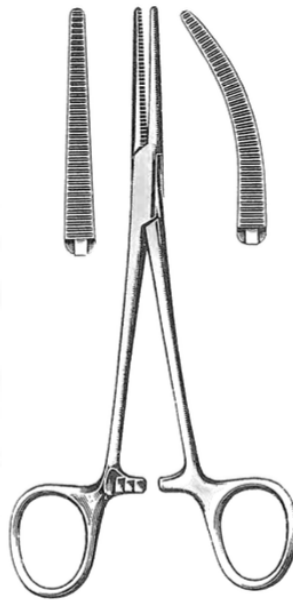

**K-12-192**  
**K-12-193**

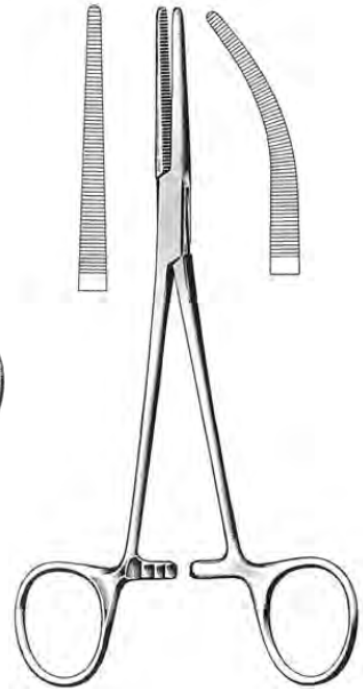

**K-12-194**  
**K-12-195**

## PINZAS HEMOSTÁTICAS

- |                 |                                             |
|-----------------|---------------------------------------------|
| <b>K-12-188</b> | Pinza de KELLY, Recta, 5½" (14 cm)          |
| <b>K-12-189</b> | Pinza de KELLY, Curva, 5½" (14 cm)          |
| <b>K-12-190</b> | Pinza de KELLY-RANKIN, Recta, 6¼" (15.9 cm) |
| <b>K-12-191</b> | Pinza de KELLY-RANKIN, Curva, 6¼" (15.9 cm) |
| <b>K-12-192</b> | Pinza de CRILE, Recta, 5½" (14 cm)          |
| <b>K-12-193</b> | Pinza de CRILE, Curva, 5½" (14 cm)          |
| <b>K-12-194</b> | Pinza de CRILE, Recta, 6¼" (15.9 cm)        |
| <b>K-12-195</b> | Pinza de CRILE, Curva, 6¼" (15.9 cm)        |



**MASTERMED**  
MASTERS EN PRODUCTOS MÉDICOS

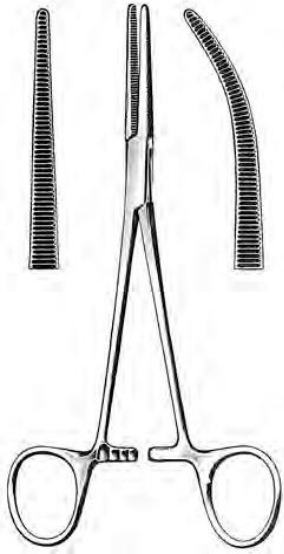

**K-12-196**  
**K-12-197**

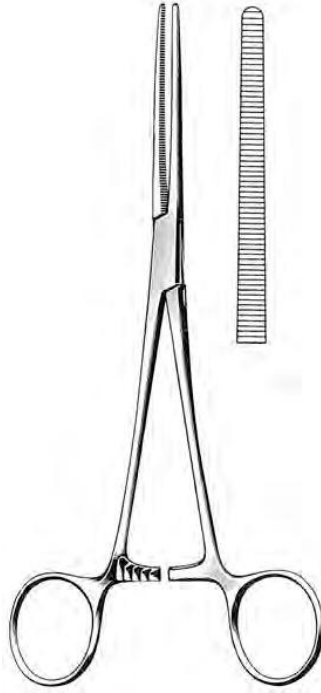

**K-12-198**  
to  
**K-12-207**

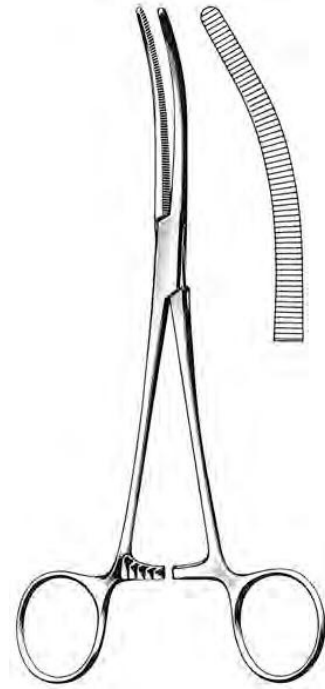

**K-12-199 to**  
**K-12-207**

## PINZAS HEMOSTÁTICAS

<b>K-12-196</b>	Pinza de ROCHESTER-PEAN, Recta, 5½" (14 cm)
<b>K-12-197</b>	Pinza de ROCHESTER-PEAN, Curva, 5½" (14 cm)
<b>K-12-198</b>	Pinza de ROCHESTER-PEAN, Recta, 6¼" (15.9 cm)
<b>K-12-199</b>	Pinza de ROCHESTER-PEAN, Curva, 6¼" (15.9 cm)
<b>K-12-200</b>	Pinza de ROCHESTER-PEAN, Recta, 7¼" (18.4 cm)
<b>K-12-201</b>	Pinza de ROCHESTER-PEAN, Curva, 7¼" (18.4 cm)
<b>K-12-202</b>	Pinza de ROCHESTER-PEAN, Recta, 8" (20.3 cm)
<b>K-12 -202 -A</b>	Pinza de ROCHESTER-PEAN, Recta, 8½" (21.6 cm)
<b>K-12-203</b>	Pinza de ROCHESTER-PEAN, Curva, 8" (20.3 cm)
<b>K-12 -203 -A</b>	Pinza de ROCHESTER-PEAN, Curva, 8½" (21.6 cm)
<b>K-12-204</b>	Pinza de ROCHESTER-PEAN, Recta, 9" (22.9 cm)...
<b>K-12-205</b>	Pinza de ROCHESTER-PEAN, Curva, 9" (22.9 cm)
<b>K-12 -204 -A</b>	Pinza de ROCHESTER-PEAN, Recta, 9½" (24.1 cm)
<b>K-12 -205 -A</b>	Pinza de ROCHESTER-PEAN, Curva, 9½" (24.1 cm)
<b>K-12-206</b>	Pinza de ROCHESTER-PEAN, Recta, 10" (25.4 cm)
<b>K-12-207</b>	Pinza de ROCHESTER-PEAN, Curva, 10" (25.4 cm)



MASTERMED  
MASTERS EN PRODUCTOS MÉDICOS

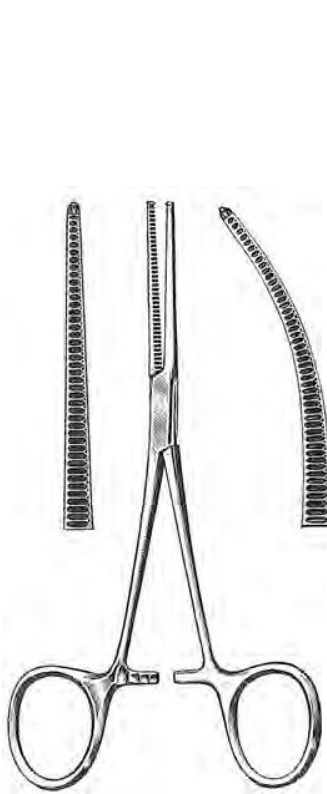

**K-12-211**  
**K-12-212**



**K-12-213**  
**to**  
**K-12-218-E**



**K-12-214**  
**to**  
**K-12-218-E**

## PINZAS HEMOSTÁTICAS

<b>K-12-211</b>	Pinza de KOCHER, Recta, con Dientes 1 x 2, 5½" (14 cm)
<b>K-12-212</b>	Pinza de KOCHER, Curva, con Dientes 1 x 2, 5½" (14 cm)
<b>K-12-213</b>	Pinza de ROCHESTER-OCHSNER, con Dientes 1 x 2, Recta, 6¼" (15.9 cm)
<b>K-12-214</b>	Pinza de ROCHESTER-OCHSNER, con Dientes 1 x 2, Curva, 6¼" (15.9 cm)
<b>K-12-215</b>	Pinza de ROCHESTER-OCHSNER, con Dientes 1 x 2, Recta, 7¼" (18.4 cm)
<b>K-12-216</b>	Pinza de ROCHESTER-OCHSNER, con Dientes 1 x 2, Curva, 7¼" (18.4 cm)
<b>K-12-217</b>	Pinza de ROCHESTER-OCHSNER, con Dientes 1 x 2, Recta, 8" (20.3 cm)
<b>K-12-217-A</b>	Pinza de ROCHESTER-OCHSNER, con Dientes 1 x 2, Recta, 8½" (21.6 cm)
<b>K-12-218</b>	Pinza de ROCHESTER-OCHSNER, con Dientes 1 x 2, Curva, 8" (20.3 cm)
<b>K-12-218-A</b>	Pinza de ROCHESTER-OCHSNER, con Dientes 1 x 2, Curva, 8½" (21.6 cm)
<b>K-12-218-B</b>	Pinza de ROCHESTER-OCHSNER, con Dientes 1 x 2, Recta, 9" (22.9 cm)
<b>K-12-218-C</b>	Pinza de ROCHESTER-OCHSNER, con Dientes 1 x 2, Recta, 9½" (24.1 cm)
<b>K-12-218-D</b>	Pinza de ROCHESTER-OCHSNER, con Dientes 1 x 2, Curva, 9" (22.9 cm)
<b>K-12-218-E</b>	Pinza de ROCHESTER-OCHSNER, con Dientes 1 x 2, Curva, 9½" (24.1 cm)



**MASTERMED**  
MASTERS EN PRODUCTOS MÉDICOS

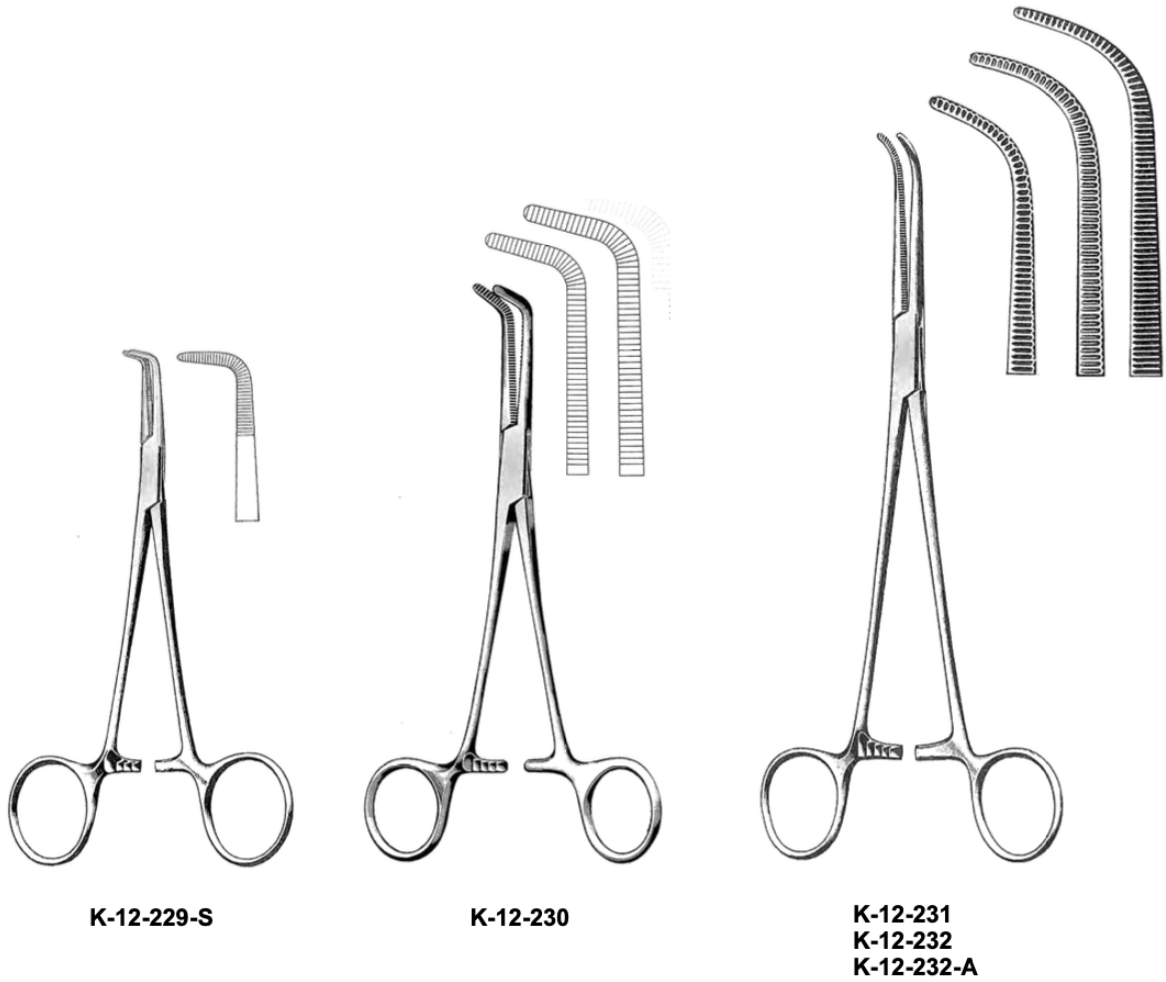
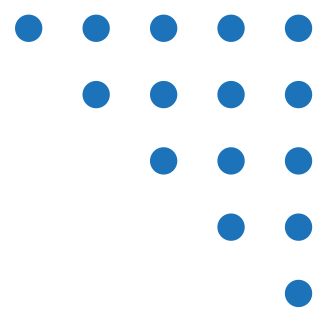

## PINZAS HEMOSTÁTICAS

- K-12-229-S** Pinza Hemostática de MIXTER, "Baby" Mandibula Angulada, 5½" (14 cm)
- K-12-230** Pinza Hemostática de MIXTER, Angulada, 6¼" (15.9 cm)
- K-12-231** Pinza Hemostática de MIXTER, Curva, 7¼" (18.4 cm)
- K-12-232** Pinza Hemostática de MIXTER, Curva, 9" (22.9 cm)
- K-12-232-A** Pinza Hemostática de MIXTER, Mandibula Curva, 11" (27.9 cm)





**MASTERMED**  
MASTERS EN PRODUCTOS MÉDICOS

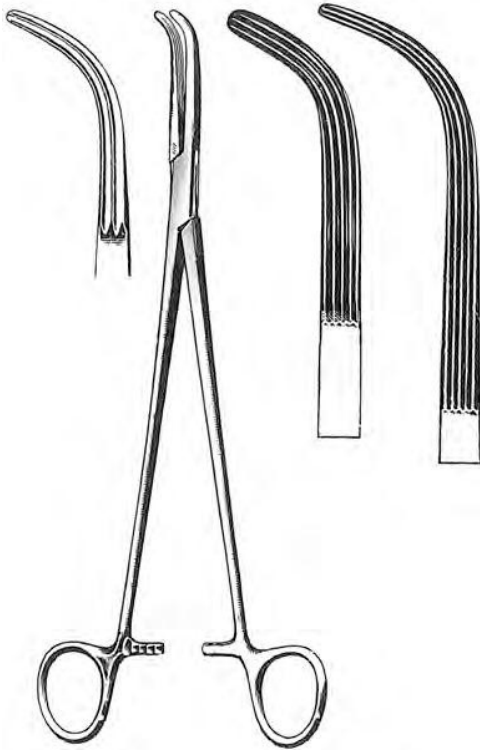
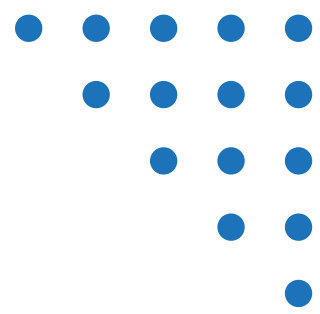

**K-26-735**  
**K-26-736**  
**K-26-737**

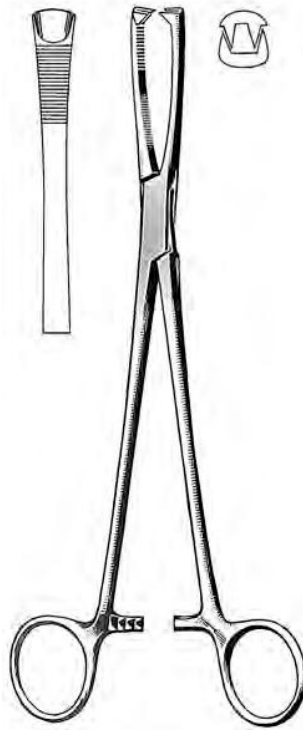

**K-27-781**

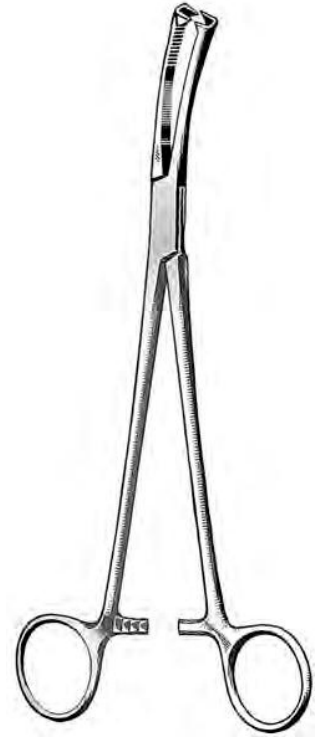

**K-27-781-A**

## PINZAS HEMOSTÁTICAS

- |                   |                                                                                 |
|-------------------|---------------------------------------------------------------------------------|
| <b>K-26-735</b>   | Pinza de Disección LAHEY, borde Longitudinal, Curva, 7½" (19.1 cm)              |
| <b>K-26-736</b>   | Pinza de Disección LAHEY, borde Longitudinal, Curva, 9" (22.9 cm)               |
| <b>K-26-737</b>   | Pinza de Disección LAHEY, borde Longitudinal, Curva, 11" (27.9 cm)              |
| <b>K-27-781</b>   | Pinza de JACOBS, Dientes 2 x 2, Recta, Mandibula Serrada, 8½" (21.6 cm)         |
| <b>K-27-781-A</b> | Pinza de JACOBS, Dientes 2 x 2, Curva de Lado, Mandibula Serrada, 8½" (21.6 cm) |





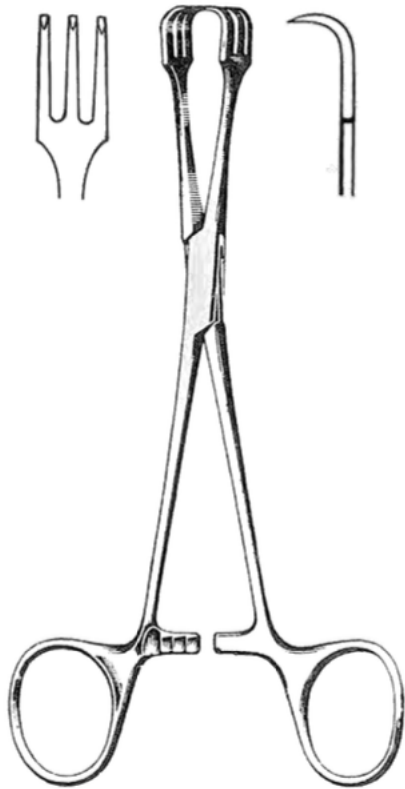
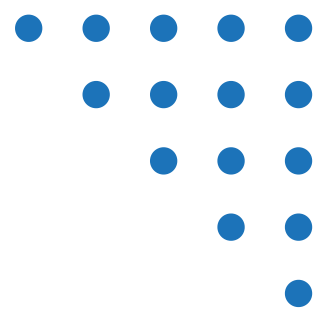

**K-27-782-A**

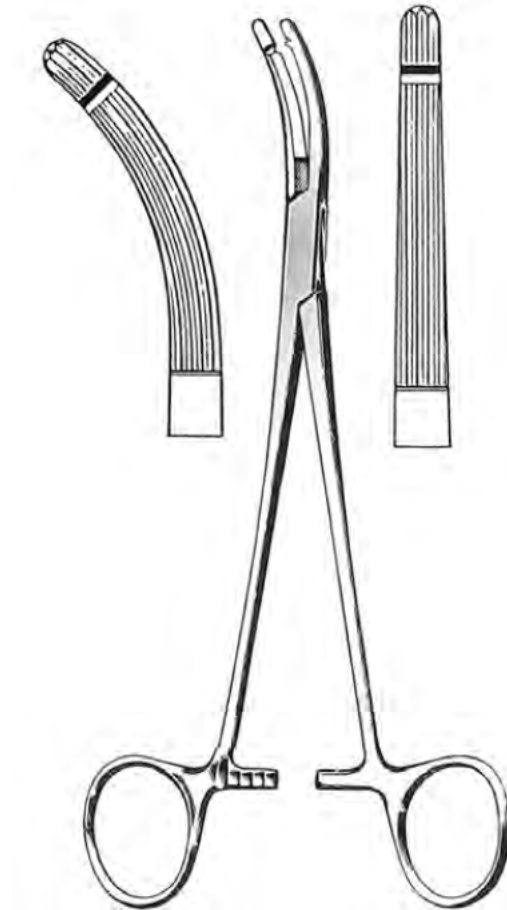

**K-27-857-A**  
**K-27-857-B**

## PINZAS HEMOSTÁTICAS

**K-27-782-A** Pinza de LAHEY con Tracción, Dientes 3 x 3, Recta, 6¼" (15.9 cm)

**K-27-857-A** Pinza de HEANEY-BALLENTINE, borde Longitudinal, Curva, 8½" (21.6 cm)

**K-27-857-B** Pinza de HEANEY-BALLENTINE, borde Longitudinal, Recta, 8½" (21.6 cm)







**MASTERMED**  
MASTERS EN PRODUCTOS MÉDICOS

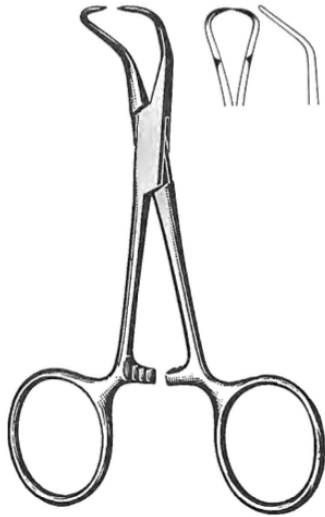
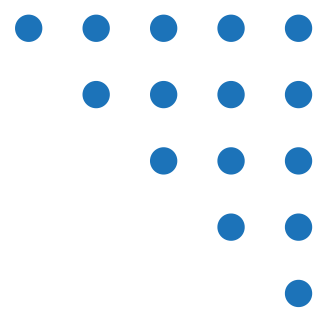

**K-13-240**



**K-13-240-A**  
**K-13-240-B**  
**K-13-241**  
**K-13-241-B**

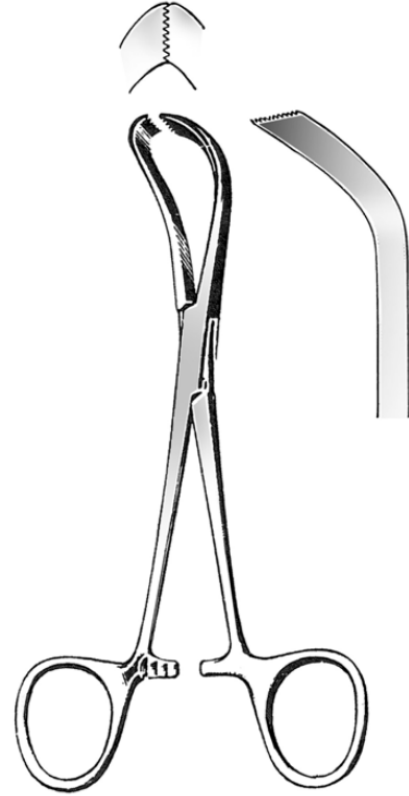

**K-13-242**  
**K-13-243**

## PINZAS DE CAMPOS

- |                     |                                                  |
|---------------------|--------------------------------------------------|
| <b>K-13-240 K-</b>  | Pinza de Campo BACKHAUS, 3½" (8.9 cm)            |
| <b>13 -240 -A</b>   | Pinza de Campo BACKHAUS, 4" (10.2 cm)            |
| <b>K-13 -240 -B</b> | Pinza de Campo BACKHAUS, 5" (12.7 cm)            |
| <b>K-13-241</b>     | Pinza de Campo BACKHAUS, 5¼" (13.3 cm)           |
| <b>K-13 -241 -B</b> | Pinza de Campo BACKHAUS, 6" (15.2 cm)            |
| <b>K-13-242</b>     | Pinza de Campo LORNA, Atraumática, 4" (10.2 cm)  |
| <b>K-13-243</b>     | Pinza de Campo LORNA, Atraumática, 5¼" (13.3 cm) |





**MASTERMED**  
MASTERS EN PRODUCTOS MÉDICOS

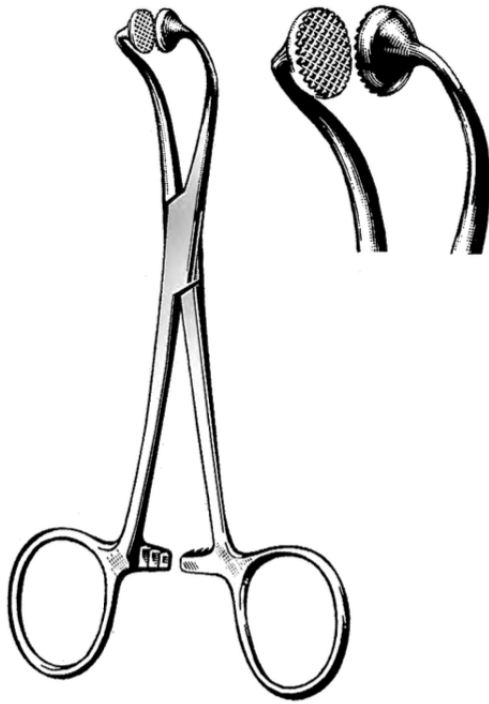
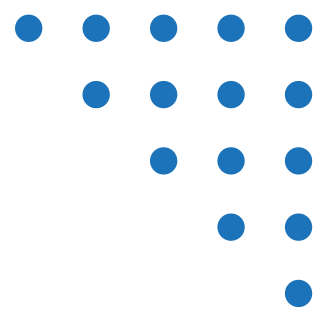

**K-13-244**

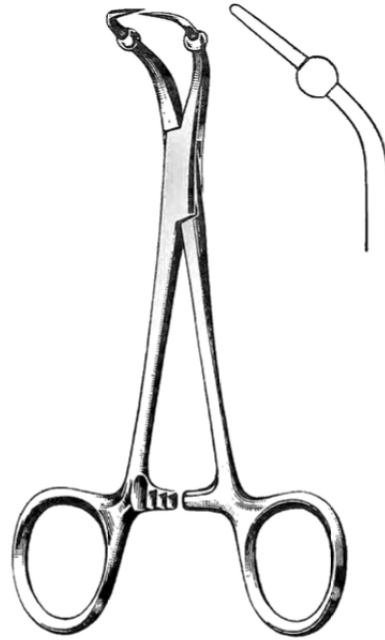

**K-13-246**

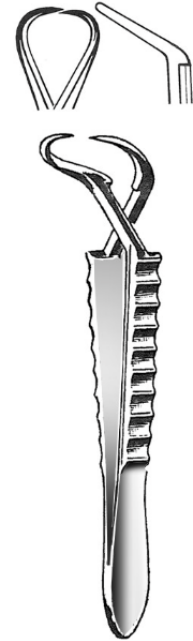

**K-13-248**

## PINZAS DE CAMPO

**K-13-244** Pinza de Campo HOFF, atraumática, 4" (10.2 cm)

**K-13-246** Pinza de Campo ROEDER, con tope de bolas, 5¼" (13.3 cm)

**K-13-248** Pinza de Campo JONES, Cruzada, 3¼" (9.5 cm)





**MASTERMED**  
MASTERS EN PRODUCTOS MÉDICOS



**K-14-252**



**K-14-253**

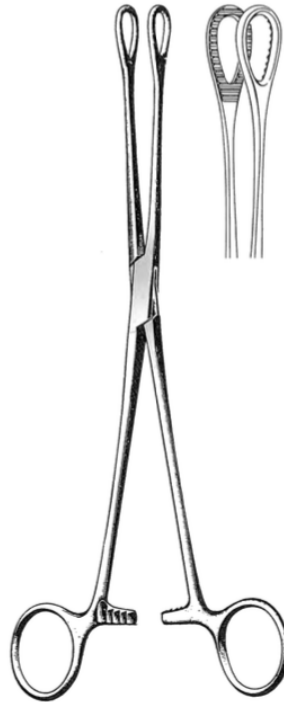

**K-14-254  
K-14-256**

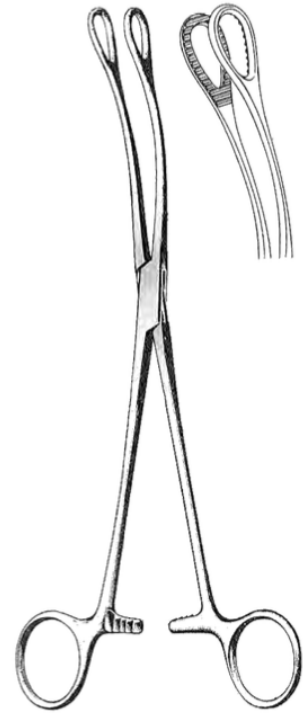

**K-14-255  
K-14-257**

## PORTA ESPONJAS

- K-14-252 Pinza Porta-Esponjas BALLENGER, Boca Estriada, Recta 7" (17.8cm)
- K-14-253 Pinza Porta-Esponjas BALLENGER, Boca Estriada, Curva, 7" (17.8 cm)
- K-14-254 Pinza Porta-Esponjas FOERSTER, Boca Lisa, Recta, 9½" (24.1 cm)
- K-14-255 Pinza Porta-Esponjas FOERSTER, Boca Lisa, Curva, 9½" (24.1 cm)
- K-14-256 Pinza Porta-Esponjas FOERSTER, Boca Estriada, Recta, 9½" (24.1 cm)
- K-14-257 Pinza Porta-Esponjas FOERSTER, Boca Estriada, Curva, 9½" (24.1 cm)



**MASTERMED**  
MASTERS EN PRODUCTOS MÉDICOS

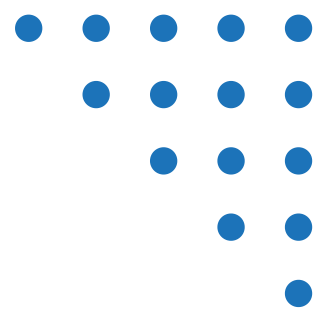

**K-14-256-A**  
**K-14-256-B**

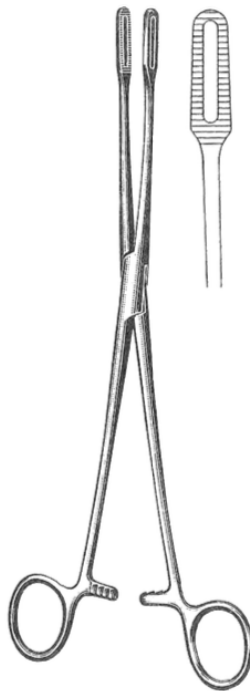

**K-14-256-C**

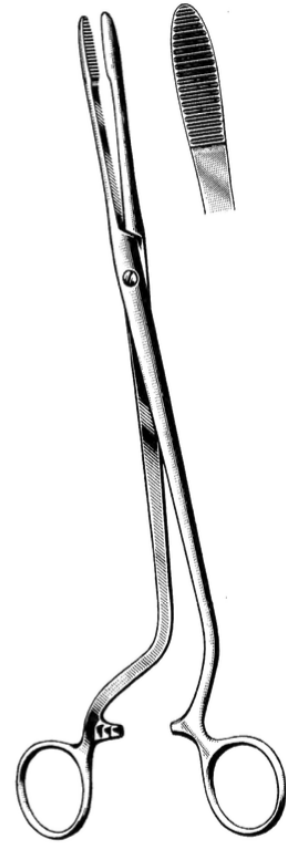

**K-14-258**

## PORTA ESPONJAS

- K-14 -256 -A** Pinza Porta Esponja RAMPLEY, Recta, 7" (17.8 cm)
- K-14 -256 -B** Pinza Porta Esponja RAMPLEY, Recta, 10" (25.4 cm)
- K-14 -256 -C** Pinza Porta Esponja BAUER, Recta, 9½" (24.1 cm)
- K-14-258** Pinza Uterina CHERON, Aros angulados hacia un lado, 9½" (24.1 cm)





**MASTERMED**  
MASTERS EN PRODUCTOS MÉDICOS

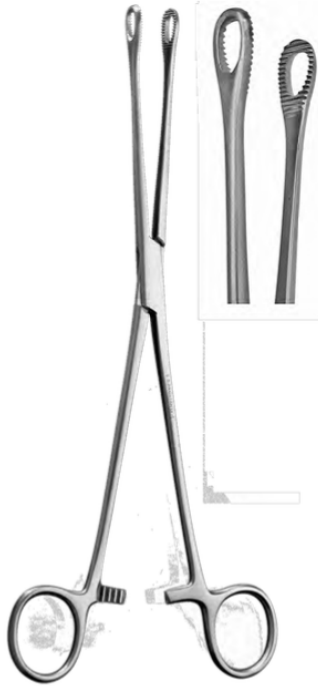

**K-14-265**



**K-14-270**



**K-27-775-A**



**K-27-775-B**

## PORTA ESPONJAS

- |                   |                                                          |
|-------------------|----------------------------------------------------------|
| <b>K-14-265</b>   | Pinza de Anillo Pequeño de Huevo Recta, 9½" (24.1 cm)    |
| <b>K-14-270</b>   | Pinza de Anillo Pequeño de Huevo Curva, 9½" (24.1 cm)    |
| <b>K-27-775-A</b> | Porta Esponja FLETCHER, para Utero, Recta, 9½" (24.1 cm) |
| <b>K-27-775-B</b> | Porta Esponja FLETCHER, para Utero, Curva, 9½" (24.1 cm) |

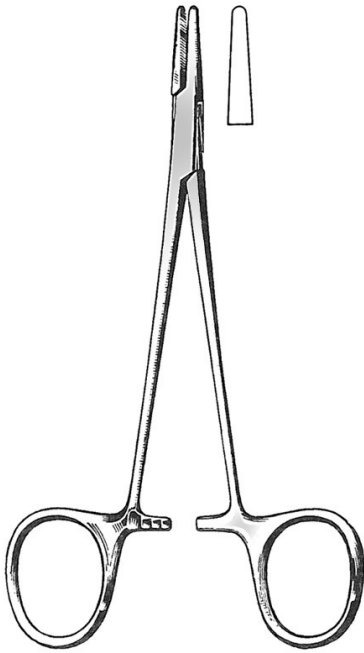
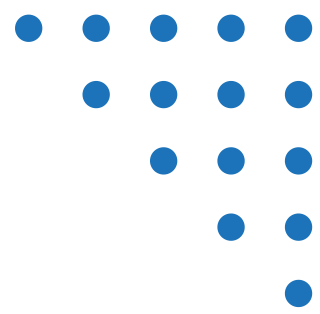

**K-16-254**

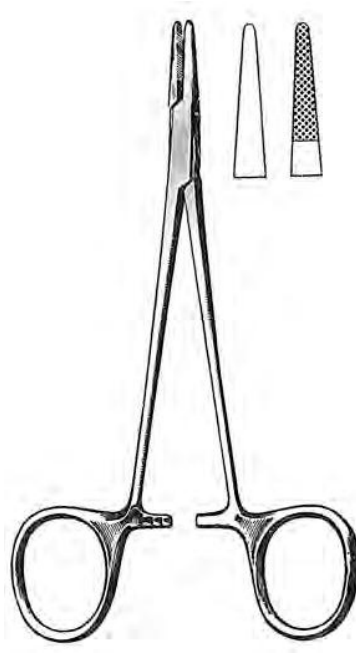

**K-16-283**  
**K-16-284**



**K-16-285**

## PORTA AGUJAS

- K-16-254** Porta Agujas WEBSTER, Mandíbulas Lisas, 5" (12.7 cm)
- K-16-283** Porta Agujas HALSEY, Mandíbulas Lisas, 5" (12.7 cm)
- K-16-284** Porta Agujas HALSEY, Mandíbulas Estriadas, 5" (12.7 cm)
- K-16-285** Porta Agujas BAUMGARTNER, 5½" (14 cm)





**MASTERMED**  
MASTERS EN PRODUCTOS MÉDICOS



**K-16-286**  
to  
**K-16-292**



**K-16-292-A**

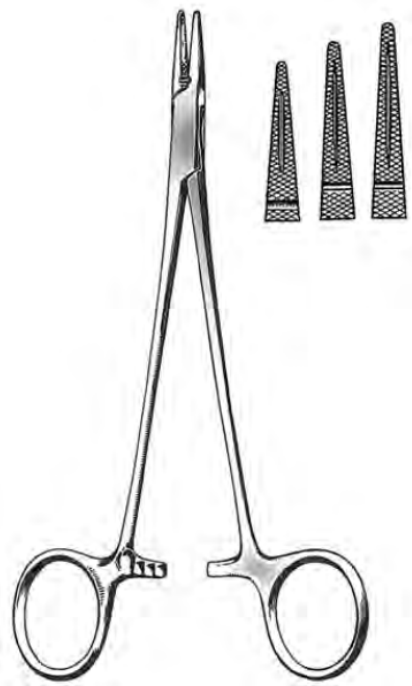

**K-16-293**  
**K-16-293-A**  
**K-16-294**

## PORTA AGUJAS

- |                   |                                                            |
|-------------------|------------------------------------------------------------|
| <b>K-16-286</b>   | Porta Agujas MAYO-HEGAR, 5½" (14 cm)                       |
| <b>K-16-287</b>   | Porta Agujas MAYO-HEGAR, 6" (15.2 cm)                      |
| <b>K-16-288</b>   | Porta Agujas MAYO-HEGAR, 7" (17.8 cm)                      |
| <b>K-16-290</b>   | Porta Agujas MAYO-HEGAR, 8" (20.3 cm)                      |
| <b>K-16-290-B</b> | Porta Agujas MAYO-HEGAR, 9" (22.9 cm)                      |
| <b>K-16-291</b>   | Porta Agujas MAYO-HEGAR, 10" (25.4 cm)                     |
| <b>K-16-292</b>   | Porta Agujas MAYO-HEGAR, 12" (30.5 cm)                     |
| <b>K-16-292-A</b> | Porta Agujas SAROT, Modelo Ligero, Satinado, 7½" (19.1 cm) |
| <b>K-16-293</b>   | Porta Agujas CRILE-WOOD, 6" (15.2 cm)                      |
| <b>K-16-293-A</b> | Porta Agujas CRILE-WOOD (DEBAKEY), 7" (17.8 cm)            |
| <b>K-16-294</b>   | Porta Agujas CRILE-WOOD (DEBAKEY), 8" (20.3 cm)            |



**MASTERMED**  
MASTERS EN PRODUCTOS MÉDICOS

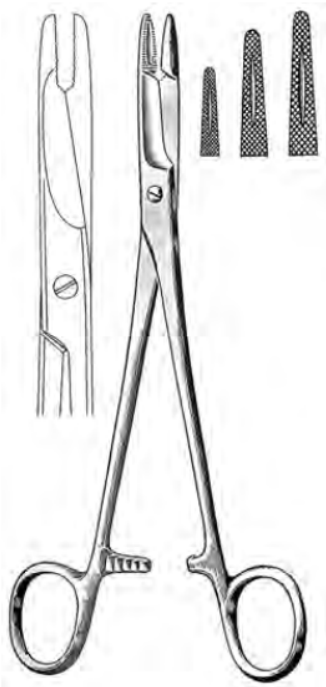
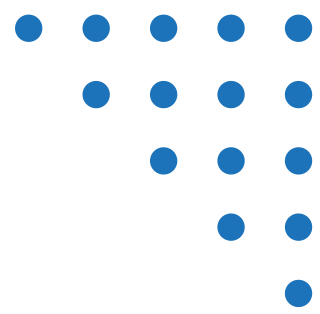

**K-16-296**  
**K-16-297**  
**K-16-298**



**K-16-299**  
**K-16-300**



**K-16-301**

## PORTA AGUJAS

- |                 |                                           |
|-----------------|-------------------------------------------|
| <b>K-16-296</b> | Porta Agujas OLSEN-HEGAR, 5½" (14 cm)     |
| <b>K-16-297</b> | Porta Agujas OLSEN-HEGAR, 6½" (16.5 cm)   |
| <b>K-16-298</b> | Porta Agujas OLSEN-HEGAR, 7¼" (18.4 cm)   |
| <b>K-16-299</b> | Porta Agujas MATHIEU, 5½" (14 cm)         |
| <b>K-16-300</b> | Porta Agujas MATHIEU, 6½" (16.5 cm)       |
| <b>K-16-301</b> | Porta Agujas HEANEY, Curva, 8½" (21.6 cm) |





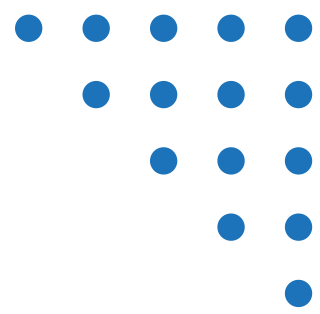

**K-16-302**

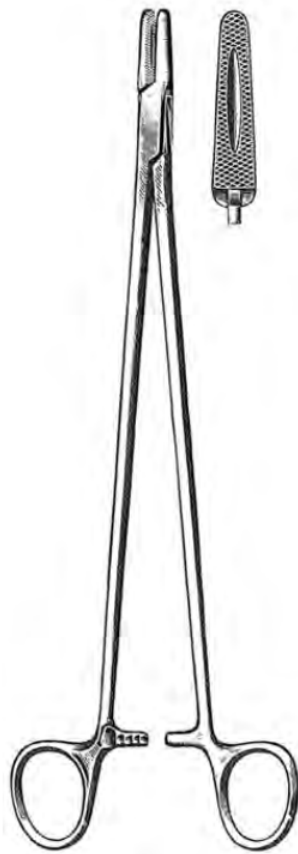

**K-16-303**

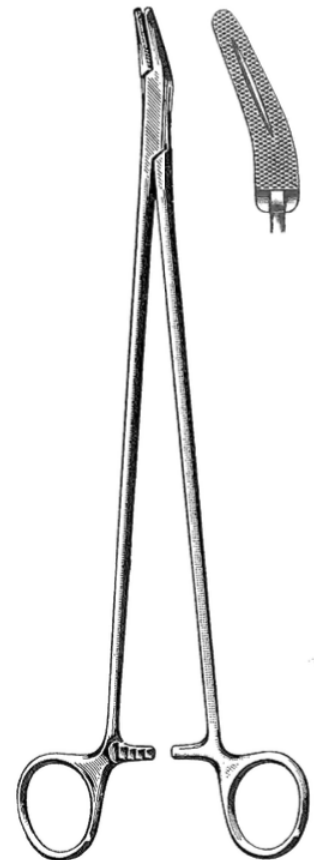

**K-16-303-A**

## PORTA AGUJAS

- K-16-302** Porta Agujas BROWN, 5¼" (13.3 cm)
- K-16-303** Porta Agujas MASSON, 10½" (26.7 cm)
- K-16-303-A** Porta Agujas FINOCHIETTO, Mandibula Angulada, Satinado, 10½" (26.7 cm)





**MASTERMED**  
MASTERS EN PRODUCTOS MÉDICOS

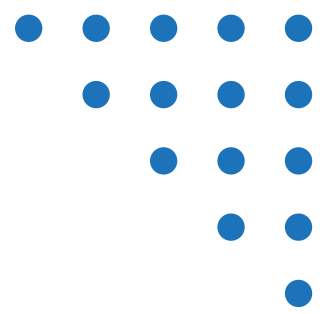

**K-16-306**



**K-16-308**



**K-16-335**

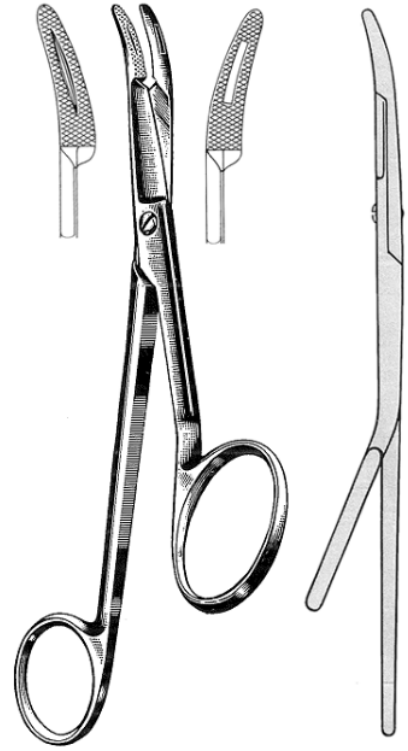

**K-16-339**

## PORTA AGUJAS

- K-16-306** Porta Agujas CASTROVIEJO, con Cerradura, Recta, Lisa, 5½".(14 cm)
- K-16-308** Porta Agujas CASTROVIEJO, sin Cerradura, Serrada, 5½" (14 cm)
- K-16-335** Porta Agujas BOYNTON, Delicada, 5" (12.7 cm)
- K-16-339** Porta Agujas GILLIES, Recta, con Tijeras para Sutura, 6½" (16.5 cm)



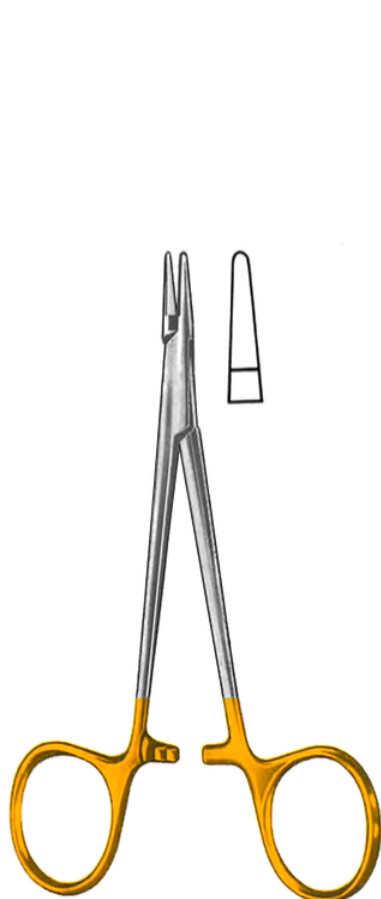
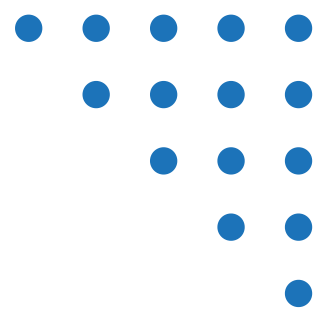

**K-35-515**

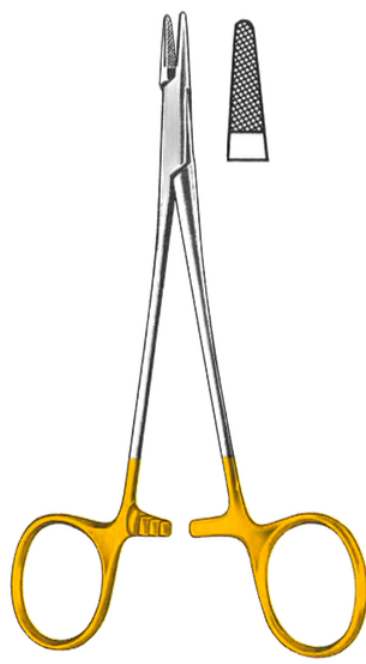

**K-35-520**



**K-35-525**  
**K-35-530**

**PORTA AGUJAS CON MANDÍBULAS - DIAMANTE DE TUNGSTENO - CARBURO (TC) LA MEJOR CALIDAD**

**K-35-515** Porta Agujas de WEBSTER, Mandíbulas Lisas, Tungsteno TC, 4¾" (12.1 cm)

**K-35-520** Porta Agujas de BAUMGARTNER, Tungsteno TC, 5½" (14 cm)

**K-35-525** Porta Agujas de HALSEY, Liso, Tungsteno TC, 5" (12.7 cm)

**K-35-530** Porta Agujas de HALSEY, Estriadas, Tungsteno TC, 5"(12.7 cm)





**MASTERMED**  
MASTERS EN PRODUCTOS MÉDICOS

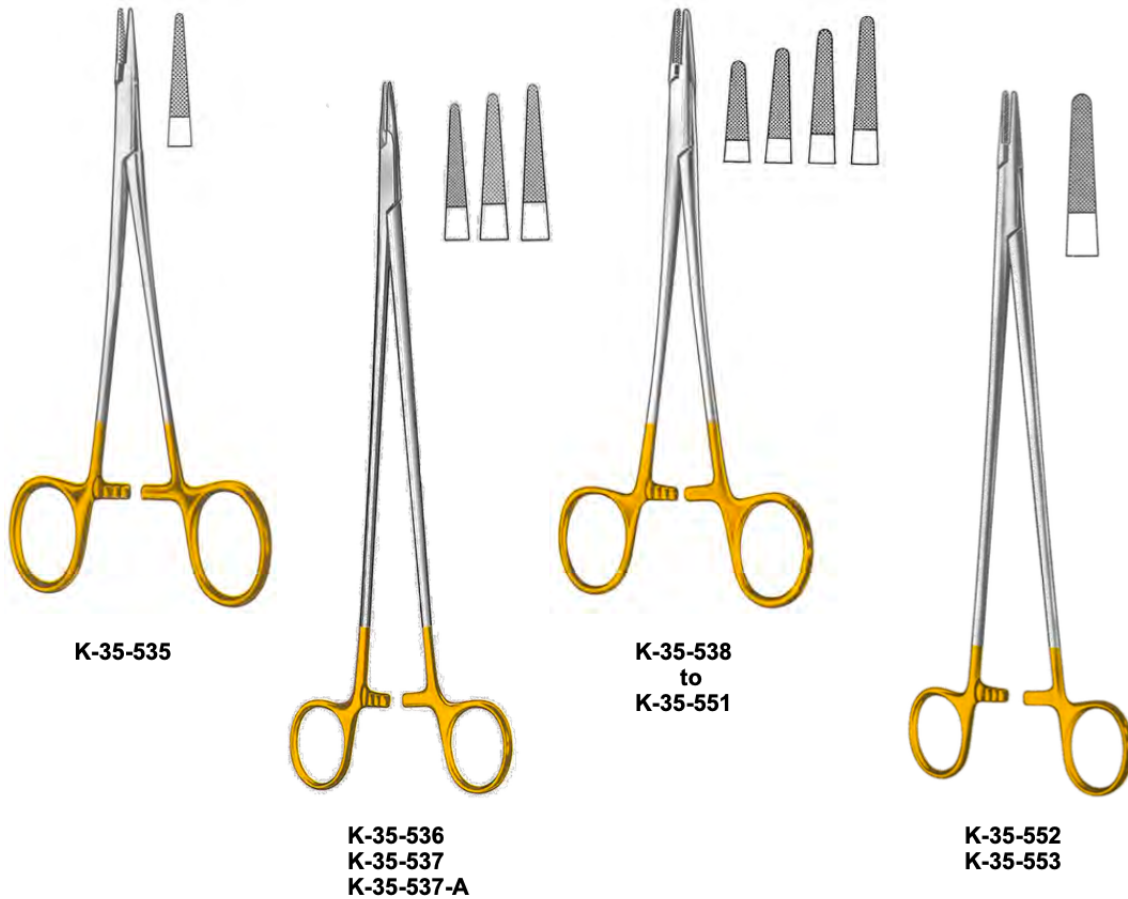

## PORTA AGUJAS CON MANDÍBULAS - DIAMANTE DE TUNGSTENO - CARBURO (TC) LA MEJOR CALIDAD

- K-35-535** Porta Agujas de CRILE-WOOD, Tungsteno, 6" (15.2 cm)
- K-35-536** Porta Agujas de CRILE-WOOD (DEBAKEY) Tungsteno TC, 7" (17.8 cm)  
**K-35-537** Porta Agujas de CRILE-WOOD (DEBAKEY) Tungsteno TC, 8" (20.3 cm)  
**K-35-537-A** Porta Agujas de CRILE-WOOD (DEBAKEY) Tungsteno TC, 9" (22.9 cm)
- K-35-538** Porta Agujas de MAYO-HEGAR, Tungsteno TC, 5½" (14 cm)  
**K-35-542** Porta Agujas de MAYO-HEGAR, Tungsteno TC, 6" (15.2 cm)  
**K-35-545** Porta Agujas de MAYO-HEGAR, Tungsteno TC, 7" (17.8 cm)  
**K-35-550** Porta Agujas de MAYO-HEGAR, Tungsteno TC, 8" (20.3 cm)  
**K-35-550-A** Porta Agujas de MAYO-HEGAR, Tungsteno TC, 9" (22.9 cm)  
**K-35-551** Porta Agujas de MAYO-HEGAR, Tungsteno TC, 9½" (24.1 cm)
- K-35-552** Porta Agujas de MAYO-HEGAR (MASSON) Estriadas, Tungsteno TC, 10½" (26.7 cm)  
**K-35-553** Porta Agujas de MAYO-HEGAR (MASSON) Estriadas, Tungsteno TC, 12" (30.5 cm)



**MASTERMED**  
MASTERS EN PRODUCTOS MÉDICOS



**K-17-316  
to  
K-17-323**



**K-18-329  
to  
K-18-335**

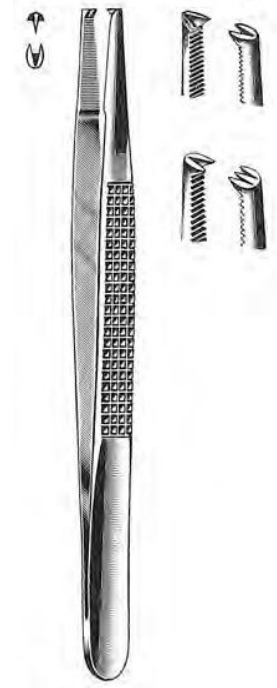

**K-18-349  
K-18-349-A**

## PINZAS DE DISECCIÓN Y QUIRÚRGICAS

- K-17-316** Pinza de Disección, Estriadas Sin Dientes, 4½" (11.4 cm)
- K-17-317** Pinza de Disección, Estriadas Sin Dientes, 5" (12.7 cm)
- K-17-318** Pinza de Disección, Estriadas Sin Dientes, 5½" (14 cm)
- K-17-319** Pinza de Disección, Estriadas Sin Dientes, 6" (15.2 cm)
- K-17-321** Pinza de Disección, Estriadas Sin Dientes, 8" (20.3 cm)
- K-17-321-A** Pinza de Disección, Estriadas Sin Dientes, 7" (17.8 cm)
- K-17-322** Pinza de Disección, Estriadas Sin Dientes, 10" (25.4cm)
- K-17-323** Pinza de Disección, Estriadas Sin Dientes, 12" (30.5cm)
  
- K-18-329** Pinza Quirúrgicas, con Dientes 1 x 2, 4½" (11.4 cm)
- K-18-330** Pinza Quirúrgicas, con Dientes 1 x 2, 5" (12.7 cm)
- K-18-331** Pinza Quirúrgicas, con Dientes 1 x 2, 5½" (14 cm)
- K-18-332** Pinza Quirúrgicas, con Dientes 1 x 2, 6" (15.2 cm)
- K-18-332-A** Pinza Quirúrgicas, con Dientes 1 x 2, 7" (17.8 cm)
- K-18-333** Pinza Quirúrgicas, con Dientes 1 x 2, 8" (20.3 cm)
- K-18-334** Pinza Quirúrgicas, con Dientes 1 x 2, 10" (25.45 cm)
- K-18-335** Pinza Quirúrgicas, con Dientes 1 x 2, 12" (30.5 cm)
  
- K-18-349** Pinza Quirúrgicas, BONNEY, Dientes 1 x 2, Punta Serrada, 7" (17.8 cm)
- K-18-349-A** Pinza Quirúrgicas, BONNEY, Dientes 2 x 3, Punta Serrada, 7" (17.8 cm)



MASTERMED  
MASTERS EN PRODUCTOS MÉDICOS

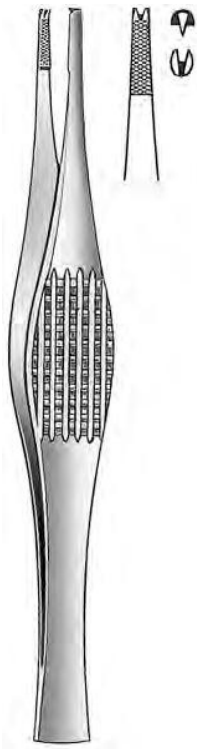
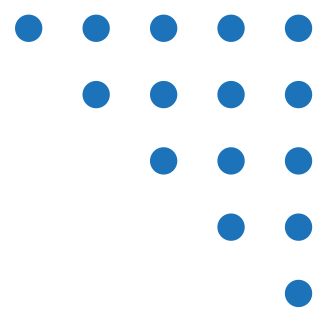

**K-18-350**

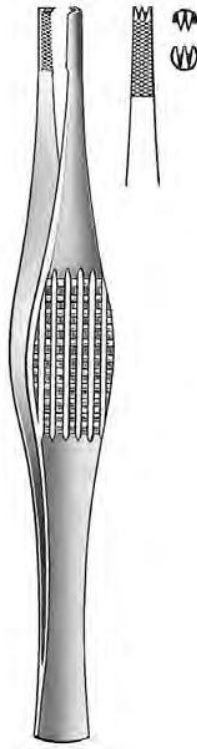

**K-18-352**



**K-19-325**  
**K-19-330**



**K-19-335**  
**K-19-340**

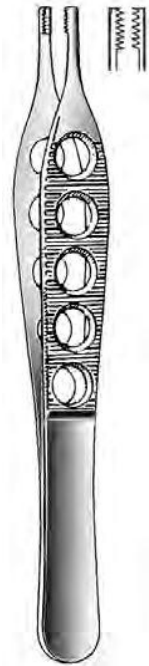

**K-19-351-S**

## PINZAS DE DISECCIÓN Y QUIRÚRGICAS

- K-18-350** Pinza Quirúrgica FERRIS-SMITH, Dientes 1 x 2, Serrada, 7" (17.8 cm)
- K-18-352** Pinza Quirúrgica FERRIS-SMITH, Dientes 2 x 3, Serrada, 7" (17.8 cm)
- K-19-325** Pinza de Dissección POTTS-SMITH, Serrada, 7" (17.8 cm)
- K-19-330** Pinza de Dissección POTTS-SMITH, Serrada, 8¼" (20.9 cm)
- K-19-335** Pinza Quirúrgica POTTS-SMITH, Dientes 1 x 2, 7" (17.8 cm)
- K-19-340** Pinza Quirúrgica POTTS-SMITH, Dientes 1 x 2, 8¼" (20.9 cm)
- K-19-351-S** Pinza Quirúrgica BROWN-ADSON, Dientes 7 x 7, 4¾" (12.1 cm)





**MASTERMED**  
MASTERS EN PRODUCTOS MÉDICOS

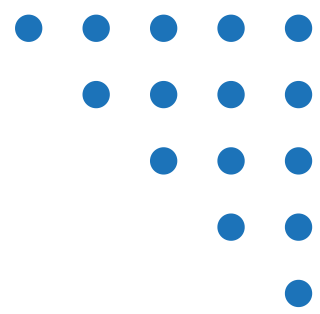

**K-19-344**



**K-19-345**



**K-19-346**  
**K-19-347**  
**K-19-348**



**K-19-349**



**K-19-350**

## PINZAS DE DISECCIÓN Y QUIRÚRGICAS

**K-19-344** Pinza de Disección SEMKEN, Estriadas, Sin Dientes, 5" (12.7 cm)

**K-19-345** Pinza Quirúrgicas SEMKEN, Dientes 1 x 2, 5" (12.7 cm)

**K-19-346** Pinza Quirúrgicas RUSA, 6" (15.2 cm)

**K-19-347** Pinza Quirúrgicas RUSA, 8" (20.3 cm)

**K-19-348** Pinza Quirúrgicas RUSA, 10" (25.4 cm)

**K-19-349** Pinza de Disección ADSON, Estriadas, Sin Dientes, 4¾" (12.1 cm)

**K-19-350** Pinza Quirúrgicas ADSON, Dientes 1 X 2, 4¾" (12.1 cm)







**MASTERMED**  
MASTERS EN PRODUCTOS MÉDICOS



**K-24-663**

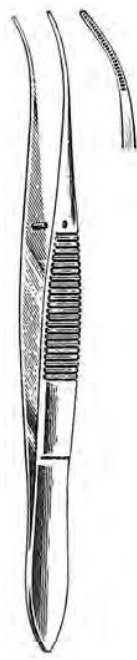

**K-24-664**



**K-24-665**



**K-24-666**



**K-24-667**



**K-24-668**

## PINZA FINA DE DISECCIÓN

- K-24-663** Pinza de Disección FINE, Recta, Serrada, 4" (10.2 cm)
- K-24-664** Pinza de Disección FINE, Curva, Serrada, 4" (10.2 cm)
- K-24-665** Pinza de Disección FINE, Curva Completa, Serrada, 4" (10.2 cm)
- K-24-666** Pinza de Disección RIS, Dientes 1 x 2, Recta, 4" (10.2 cm)
- K-24-667** Pinza de Disección IRIS, Dientes 1 x 2, Curva, 4" (10.2 cm)
- K-24-668** Pinza de Disección IRIS, Dientes 1 x 2, Curva Completa, 4" (10.2 cm)



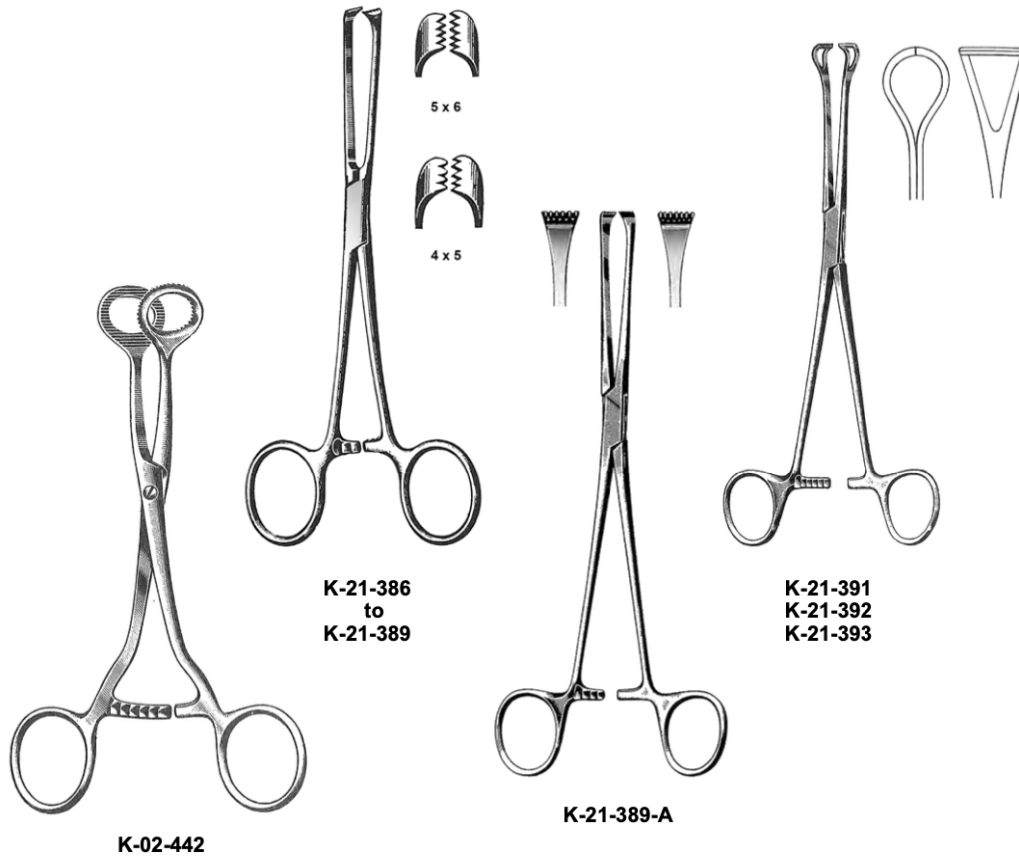
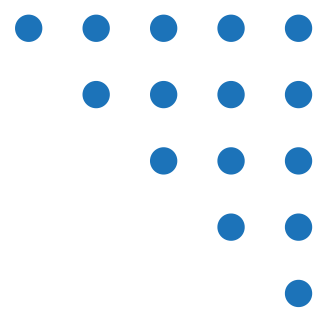

## PINZAS INTESTINALES

- |                   |                                                               |
|-------------------|---------------------------------------------------------------|
| <b>K-02-442</b>   | Pinza intestinal de COLLIN, Oval, 6¾" (17.1 cm)               |
| <b>K-21-386</b>   | Pinza Intestinal de ALLIS, Dientes 4 x 5, 6" (15.2 cm)        |
| <b>K-21-387</b>   | Pinza Intestinal de ALLIS, Dientes 5 x 6, 6" (15.2 cm)        |
| <b>K-21-388</b>   | Pinza Intestinal de ALLIS, Dientes 5 x 6, 7½" (19.1 cm)       |
| <b>K-21-388-B</b> | Pinza Intestinal de ALLIS, Dientes 6 x 7, 9½" (24.1 cm)       |
| <b>K-21-389</b>   | Pinza Intestinal de ALLIS, Dientes 5 x 6, 10" (25.4 cm)       |
| <b>K-21-389-A</b> | Pinza Intestinal de THOMAS-ALLIS, Dientes 6 x 7, 8" (20.3 cm) |
| <b>K-21-391</b>   | Pinza Intestinal de BABCOCK, 6¼" (15.9 cm)                    |
| <b>K-21-392</b>   | Pinza Intestinal de BABCOCK, 7¾" (19.7 cm)                    |
| <b>K-21-393</b>   | Pinza Intestinal de BABCOCK, 9½" (24.1 cm)                    |





**MASTERMED**  
MASTERS EN PRODUCTOS MÉDICOS

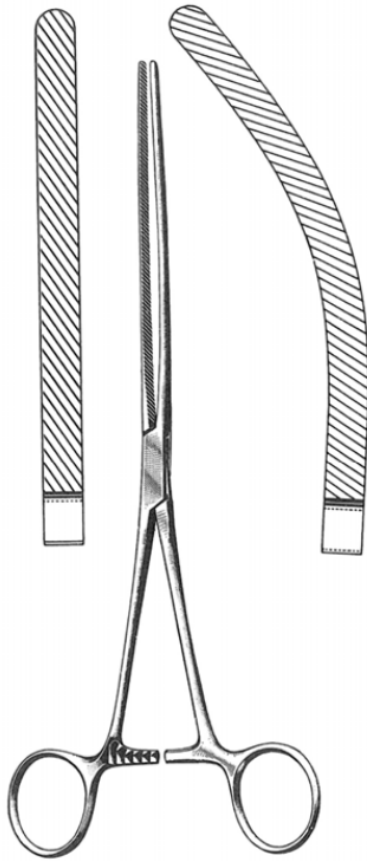
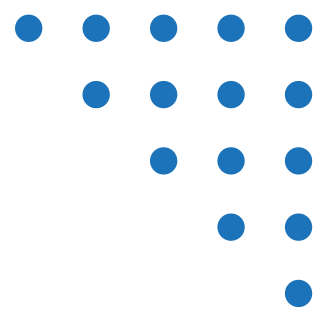

**K-21-394**  
**K-21-395**

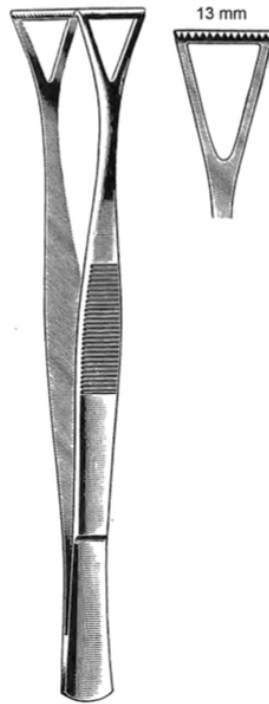

**K-21-394-A**

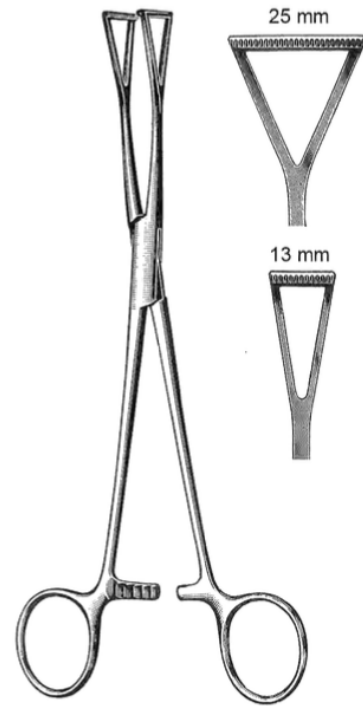

**K-21-395-A**  
**K-21-395-B**

## PINZAS INTESTINALES

- K-21-394** Clamp Intestinal de DOYEN, Recta, 9" (22.9 cm)  
**K-21-395** Clamp Intestinal de DOYEN, Curva, 8" (22.9 cm)

**K-21-394-A** Pinza Intestinal de DUVAL-COLLIN, Mandibula Triangular, ½" wide, 8" (20.3 cm)

- K-21-395-A** Pinza Intestinal de COLLIN, Mandibula Triangular, ½" wide, 8" (20.3 cm)  
**K-21-395-B** Pinza Intestinal de COLLIN, Mandibula Triangular, 1" wide, 8" (20.3 cm)





**MASTERMED**  
MASTERS EN PRODUCTOS MÉDICOS

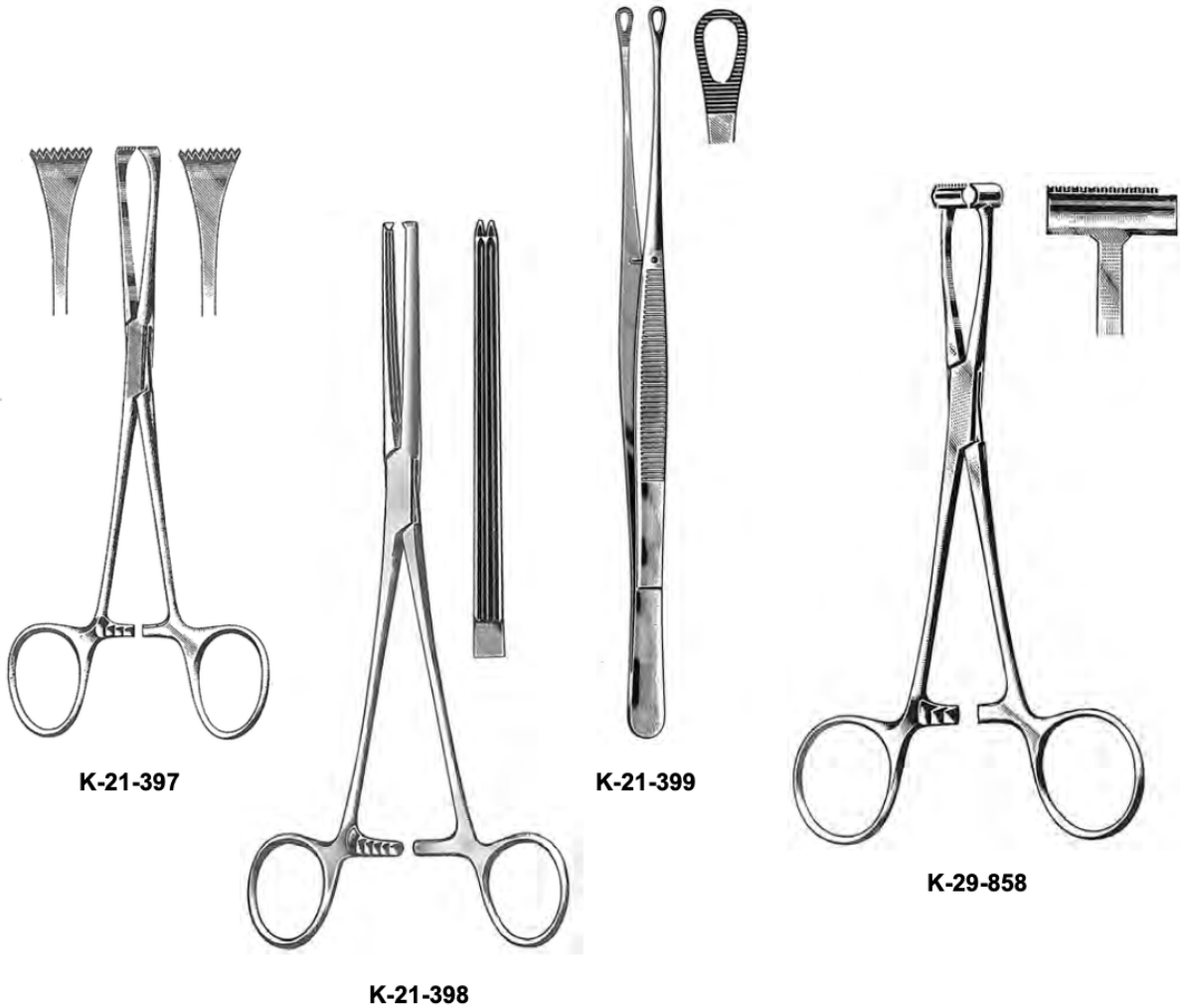

## PINZAS INTESTINALES

- K-21-397** Pinza Intestinal de ALLIS-ADAIR, Dientes 9 x 10, 6½" (16.5 cm)
- K-21-398** Pinza Intestinal de ALLEN, borde Longitudinal, Dientes 1 x 2, 8" (20.3 cm)
- K-21-399** Pinza Intestinal de SINGLEY, Fenestrada, Mandibula Serrada, 9" (22.9 cm)
- K-29-858** Pinza de PRATT, Forma de "T", 6" (15.2 cm)



**MASTERMED**  
MASTERS EN PRODUCTOS MÉDICOS

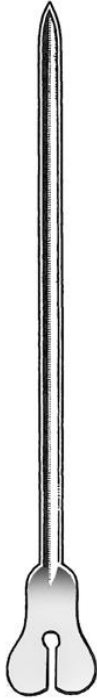

**K-22-475**  
to  
**K-22-478-B**

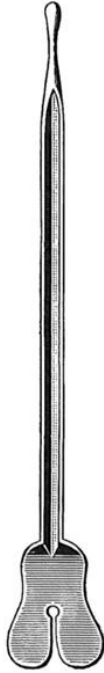

**K-22-479**  
to  
**K-22-482-B**



**K-23-488**  
to **K-23-**  
**492**



**K-23-493**  
to **K-23-**  
**499**

## SONDAS ACANALADAS Y ESTILETES

### SONDAS ACANALADAS

<b>K-22-475</b>	4½" (11.4 cm)
<b>K-22-476</b>	5" (12.7 cm)
<b>K-22-477</b>	1/2" (14 cm)
<b>K-22-478</b>	6" (15.2 cm)
<b>K-22-478-A</b>	7" (17.8 cm)
<b>K-22-478-B</b>	8" (20.3 cm)

### SONDAS ACANALADAS CON PUNTA DE BOTON

<b>K-22-479</b>	4½" (11.4 cm)
<b>K-22-480</b>	5" (12.7 cm)
<b>K-22-481</b>	5½" (14 cm)
<b>K-22-482</b>	6" (15.2 cm)
<b>K-22-482-A</b>	7" (17.8 cm)
<b>K-22-482-B</b>	8" (20.3 cm)

### ESTILETE BOLÍVAR ABOTONADO DE DOBLE PUNTA

<b>K-23-488</b>	4½" (11.4 cm)
<b>K-23-489</b>	5" (12.7 cm)
<b>K-23-490</b>	5½" (14 cm)
<b>K-23-491</b>	6" (15.2 cm)
<b>K-23-491-A</b>	7" (17.8 cm)
<b>K-23-492</b>	8" (20.3 cm)

### ESTILETE CON OJO

<b>K-23-493</b>	4½" (11.4 cm)
<b>K-23-494</b>	5" (12.7 cm)
<b>K-23-495</b>	5½" (14 cm)
<b>K-23-496</b>	6" (15.2 cm)
<b>K-23-497</b>	8" (20.3 cm)
<b>K-23-498</b>	10" (25.4 cm)
<b>K-23-499</b>	12" (30.5 cm)



**MASTERMED**  
MASTERS EN PRODUCTOS MÉDICOS

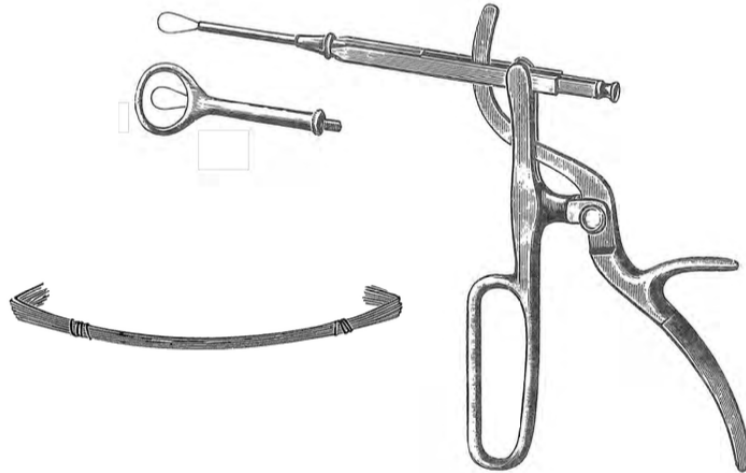
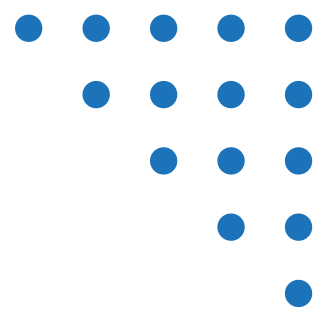

**K-32-592**



**K-12-235**  
**K-12-236**  
**K-12-237**

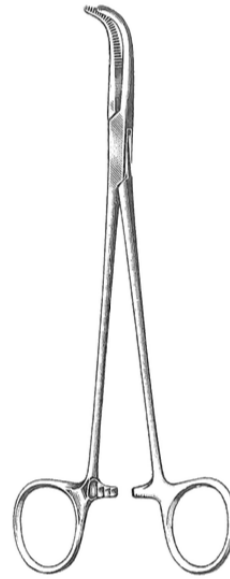

**K-12-238**

## INSTRUMENTAL TONSILA

- K-32-592** Instrumental Tonsila Tyding Snare, Completo con Punta Recta, 6 $\frac{5}{8}$ " (16.8 cm)
- K-12-235** Instrumental Tonsila SCHNIDT, Recta, 7 $\frac{1}{2}$ " (19.1 cm)
- K-12-236** Instrumental Tonsila SCHNIDT, Curva Leve, 7 $\frac{1}{2}$ " (19.1 cm)
- K-12-237** Instrumental Tonsila SCHNIDT, Curva, 7 $\frac{1}{2}$ " (19.1 cm)
- K-12-238** Instrumental Tonsila SAWTELL, Curva, 7 $\frac{1}{2}$ " (19.1 cm)





MASTERMED  
MASTERS EN PRODUCTOS MÉDICOS

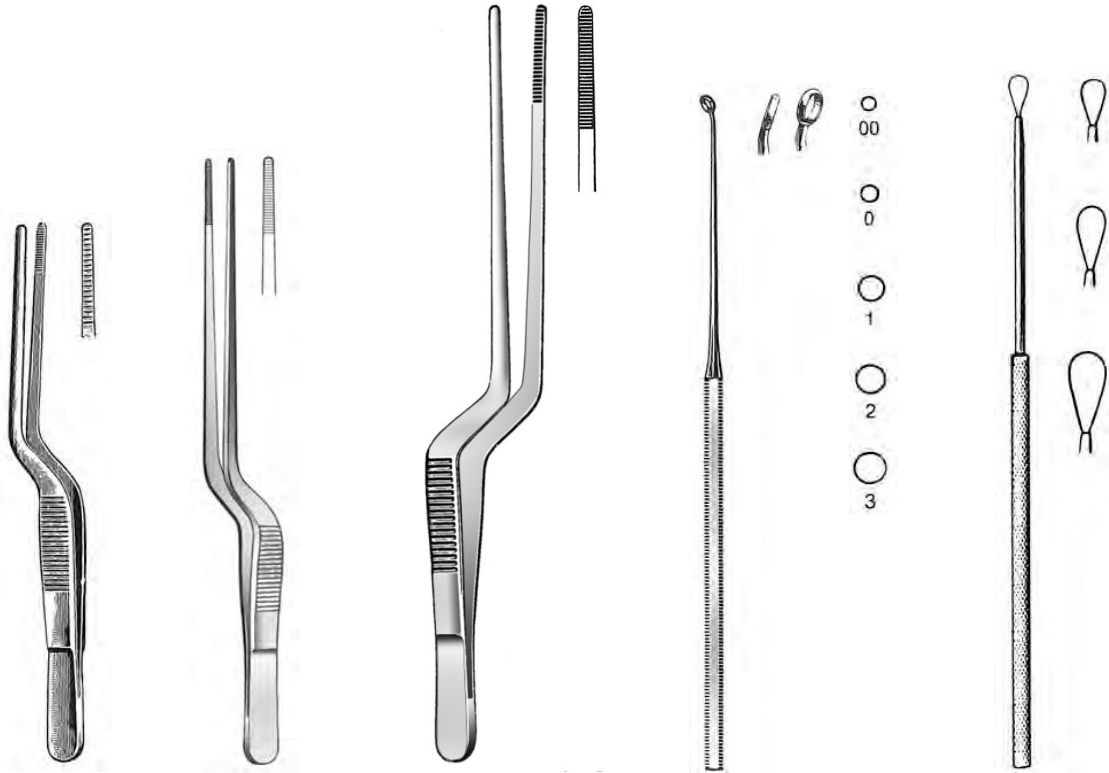
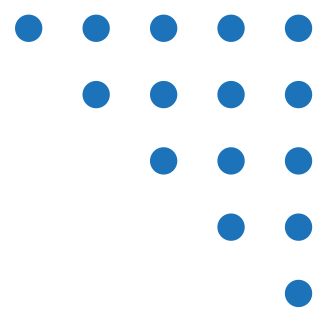

K-25-693

K-25-695

K-25-696

K-25-697  
to  
K-25-701

K-25-705  
K-25-706  
K-25-707

## INSTRUMENTAL NASAL PARA OIDO

- K-25-693** Pinza LUCAE , para el Oído, Serrada, de Bayoneta, 5½" (14 cm)
- K-25-695** Pinza JANSEN, para el Oído, Serrada, de Bayoneta, 6" (15.2 cm)
- K-25-696** Pinza de JANSEN-GRUENWALD, Serrada, Nasal, de Bayoneta, 8" (20.3 cm)
- K-25-697** Cureta BUCK, para Oído, Roma, Angulada, Tamaño 00, 6½" (16.5 cm)
- K-25-698** Cureta BUCK, para Oído, Roma, Angulada, Tamaño 0, 6½" (16.5 cm)
- K-25-699** Cureta BUCK, para Oído, Roma, Angulada, Tamaño 1, 6½" (16.5 cm)
- K-25-700** Cureta BUCK, para Oído, Roma, Angulada, Tamaño 2, 6½" (16.5 cm)
- K-25-701** Cureta BUCK, para Oído, Roma, Angulada, Tamaño 3, 6½" (16.5 cm)
- K-25-705** Asas Billeau, para Oido, Lazo Pequeño, 2.5 mm, 6½" (16.5 cm)
- K-25-706** Asas Billeau, para Oido Lazo Mediano, 3 mm, 6½" (16.5 cm)
- K-25-707** Asas Billeau, para Oido Lazo Grande, 4 mm, 6½" (16.5 cm)





**MASTERMED**  
MASTERS EN PRODUCTOS MÉDICOS

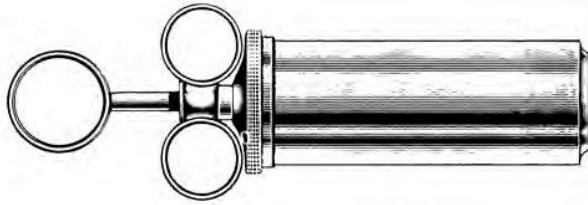

**K-25-739**

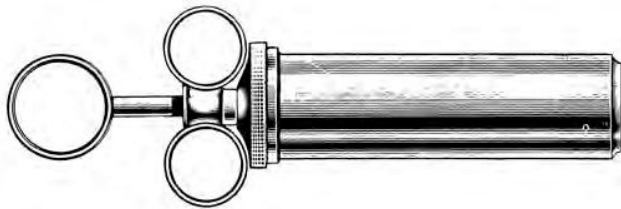
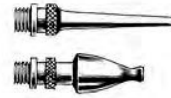

**K-25-740**

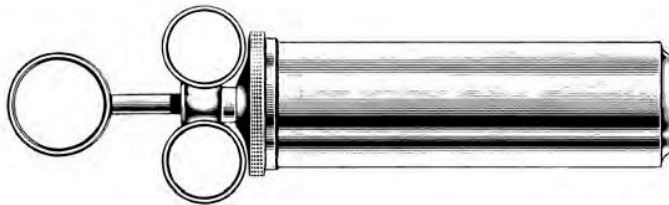
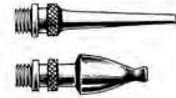

**K-25-741**

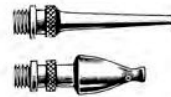

## INSTRUMENTAL NASAL Y PARA OIDO

- |                 |                            |
|-----------------|----------------------------|
| <b>K-25-739</b> | Jeringa para Oído de 2 oz. |
| <b>K-25-740</b> | Jeringa para Oído de 3 oz. |
| <b>K-25-741</b> | Jeringa para Oído de 4 oz. |



**MASTERMED**  
MASTERS EN PRODUCTOS MÉDICOS

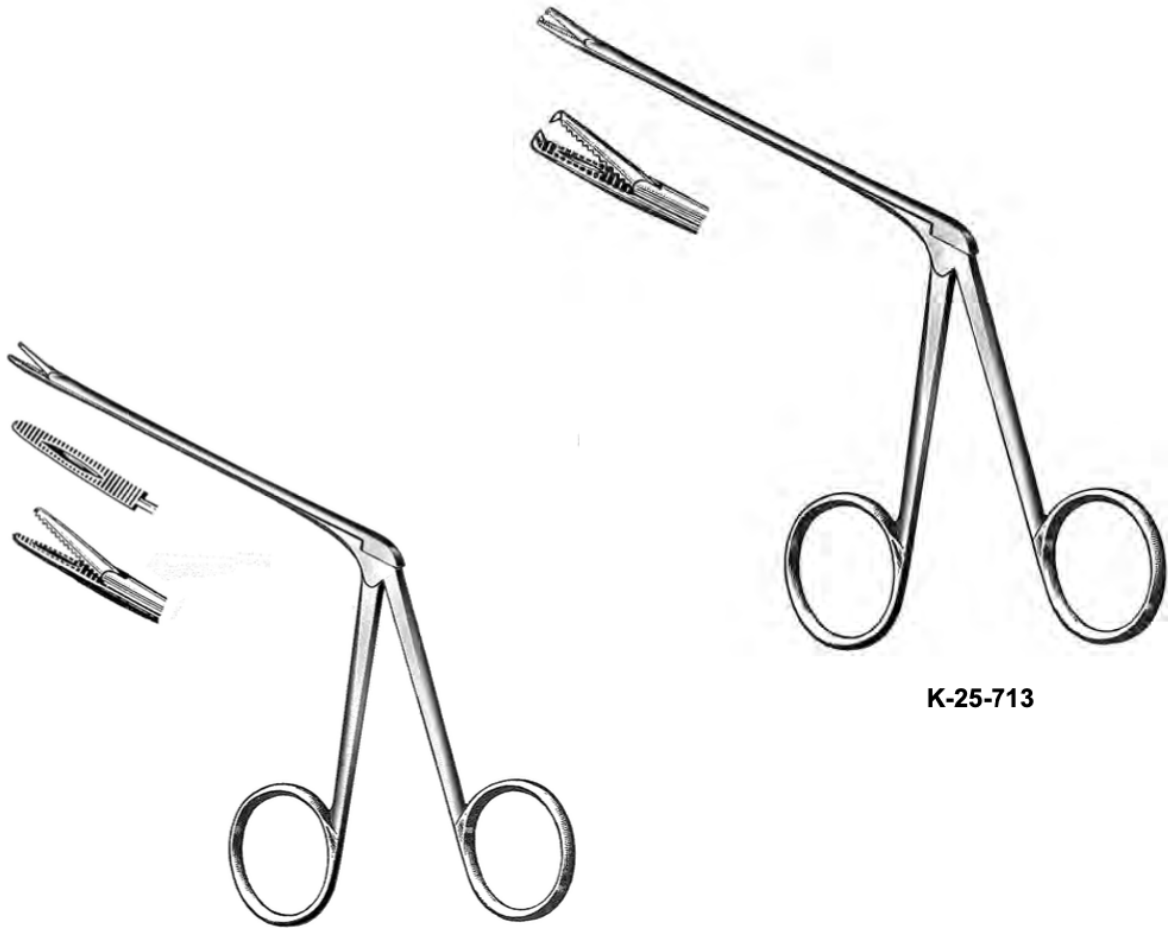
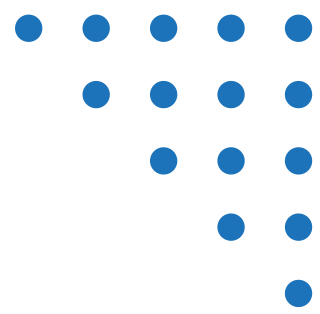

**K-25-710**  
**K-25-711**  
**K-25-712**

**K-25-713**

## INSTRUMENTAL NASAL Y PARA OIDO

- K-25-710** Pinza para Cuerpos Extraños HARTMAN, Tipo Cocodrilo, Serrada, Pequeño, 3½" (8.9 cm)
- K-25-711** Pinza para Cuerpos Extraños HARTMAN, Tipo Cocodrilo, Serrada, Mediano, 5½" (14 cm)
- K-25-712** Pinza para Cuerpos Extraños HARTMAN, Tipo Cocodrilo, Serrada, Grande, 6½" (16.5 cm)
- K-25-713** Pinza para Cuerpos Extraños HARTMAN, Tipo Cocodrilo, con Dientes 1 x 2, 6½" (16.5 cm)







**MASTERMED**  
MASTERS EN PRODUCTOS MÉDICOS

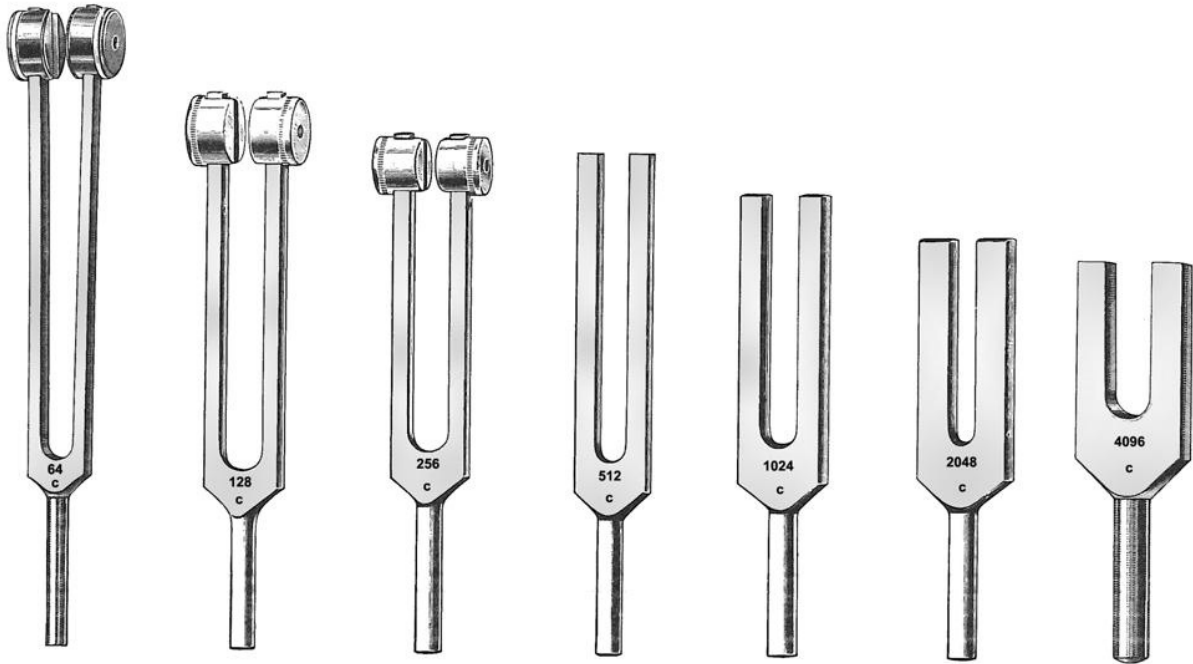
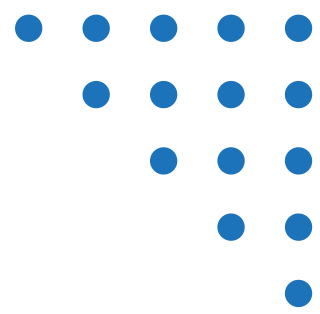

**K-25-730**

**K-25-731**

**K-25-732**

**K-25-733**

**K-25-734**

**K-25-735**

**K-25-736**

## DIAPASONES NEUROLOGICOS DE ALUMINIO

- K-25-730** Diapasón con Sordina, C-64 Vibraciones
- K-25-731** Diapasón con Sordina, C-128 Vibraciones
- K-25-732** Diapasón con Sordina, C-256 Vibraciones
- K-25-733** Diapasón sin Sordina, C-512 Vibraciones
- K-25-734** Diapasón sin Sordina, C-1024 Vibraciones
- K-25-735** Diapasón sin Sordina, C-2048 Vibraciones
- K-25-736** Diapasón sin Sordina, C-4096 Vibraciones





**MASTERMED**  
MASTERS EN PRODUCTOS MÉDICOS

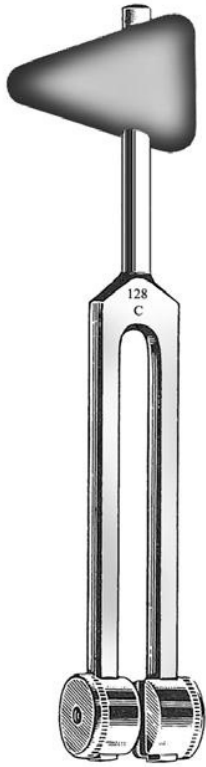

**K-25-737**



**K-25-738**

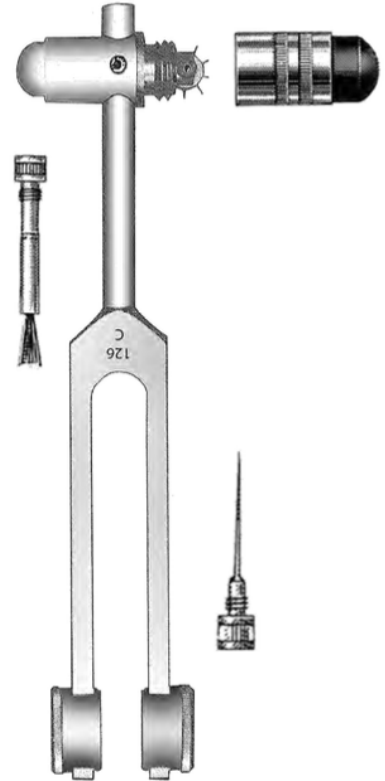

**K-25-738-A**  
**K-25-738-B**  
**K-25-738-C**

## DIAPASONES NEUROLÓGICAS DE ALUMINIO

- K-25-737** Diapasón 2 en 1, C-128V y Martillo TAYLOR con Sordina
- K-25-738** Diapasón 2 en 1, C-256V y Martillo TAYLOR con Sordina
- K-25-738-A** Diapasón y Martillo Neurológico 4 en 1 Combinacion de aguja, sepillo y molinete
- K-25-738-B** Diapasón Neurológico 5 en 1, incluye aguja, sepillo, martillo neurológico BUCK, molinete y diapason de 128Hz
- K-25-738-C** Diapasón Neurológico 5 en 1, incluye aguja, sepillo, martillo neurológico BUCK, molinete y diapason de 256Hz

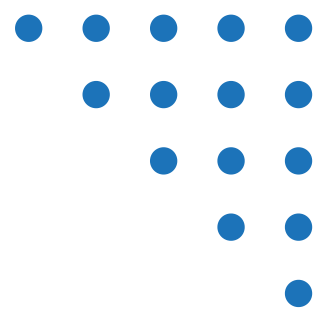

## DIAPASONES NEUROLÓGICOS DE ALUMINIO

**767-004** Diapasones, Estuche de 5: incluye C128, C256, C512, C1024, y C2048

**767-005** Diapasones, Estuche de 6: incluye C128, C256, C512, C1024, C2048 y C2096





**MASTERMED**  
MASTERS EN PRODUCTOS MÉDICOS

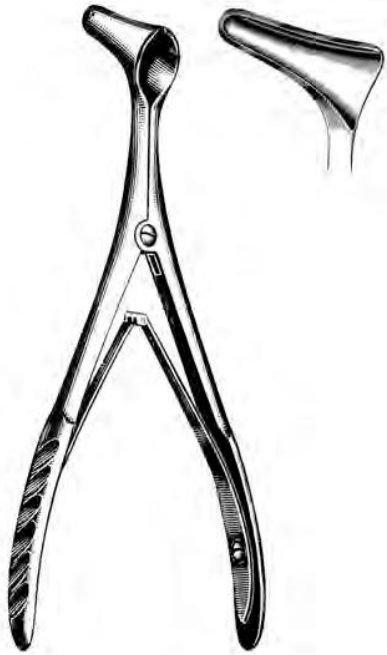
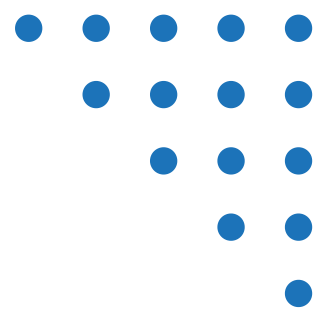

**K-25-744**

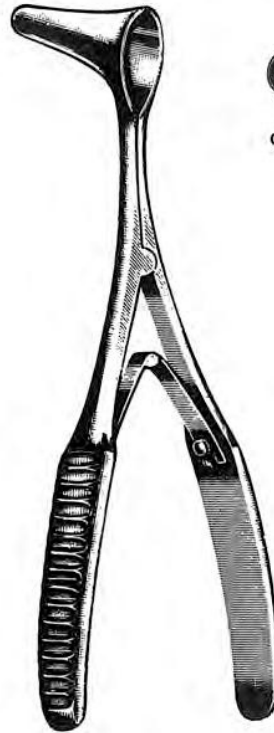

**K-25-745  
to  
K-25-748**

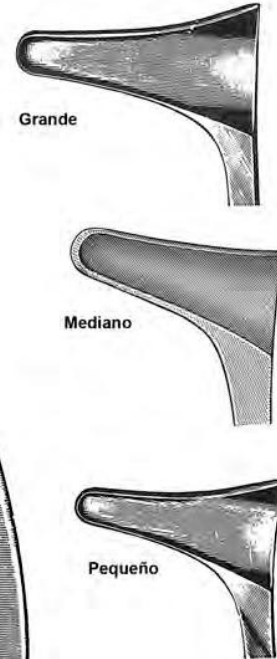

## ESPECULOS NAALES

- K-25-744** Espéculo Nasal de VIENNA, Infantil, 5 $\frac{1}{8}$ " (13 cm)
- K-25-745** Espéculo Nasal de VIENNA, Pequeño, 5 $\frac{3}{4}$ " (14.6 cm)
- K-25-746** Espéculo Nasal de VIENNA, Mediano, 5 $\frac{3}{4}$ " (14.6 cm)
- K-25-747** Espéculo Nasal de VIENNA, Grande, 5 $\frac{3}{4}$ " (14.6 cm)
- K-25-748** Espéculo Nasal de VIENNA, Extra Grande, 6" (15.2 cm)





**MASTERMED**  
MASTERS EN PRODUCTOS MÉDICOS

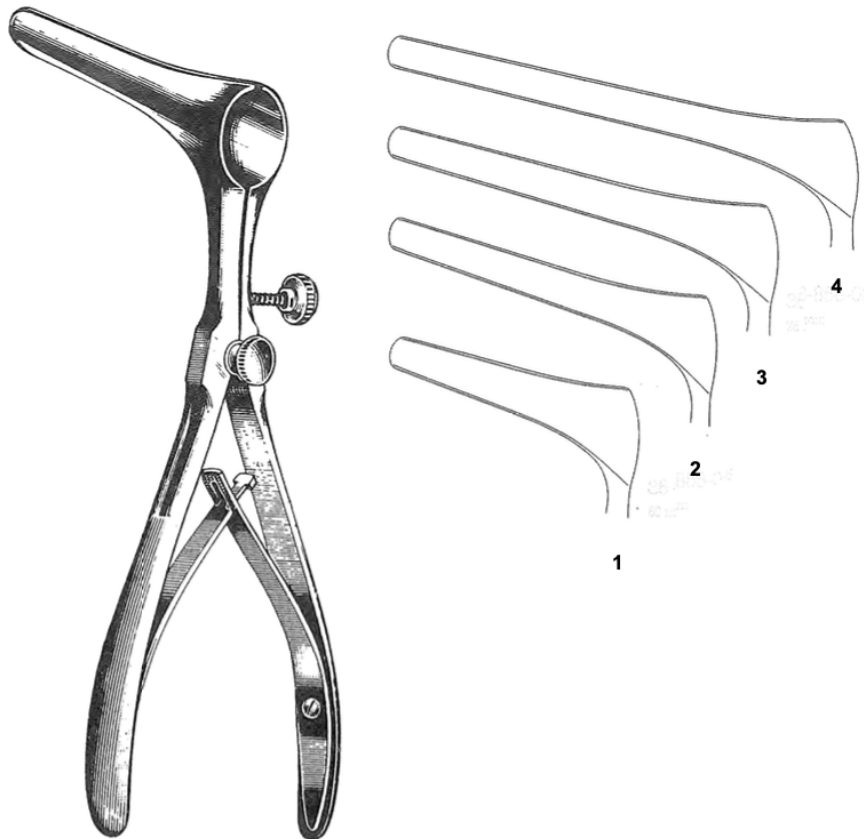
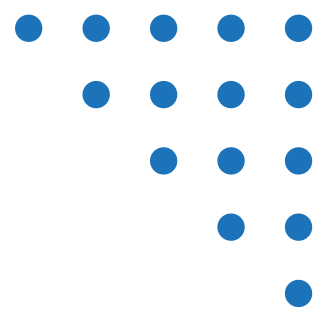

**K-25-840**  
to  
**K-25-843**

## ESPECULOS NAALES

- K-25-840**      Espéculo Nasal de KILLIAN, 2" (5.1 cm) hoja, Fig. 1, C/Tormillo, 6" (15.2 cm)
- K-25-841**      Espéculo Nasal de KILLIAN, 2½" (6.4 cm) hoja, Fig. 2, C/Tormillo, 6" (15.2 cm)
- K-25-842**      Espéculo Nasal de KILLIAN, 3" (7.6 cm) hoja, Fig 3, C/Tormillo, 6" (15.2 cm)
- K-25-843**      Espéculo Nasal de KILLIAN, 3½" (8.9 cm) hoja, Fig. 4, C/Tormillo, 6" (15.2 cm)





**MASTERMED**  
MASTERS EN PRODUCTOS MÉDICOS

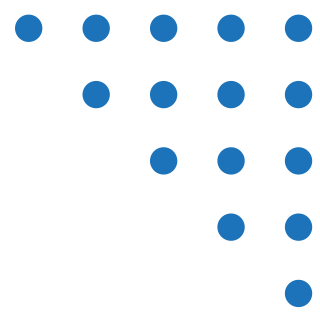

**K-25-780**  
to  
**K-25-786**



**K-25-790**  
to  
**K-25-796**

## CÁNULAS - TUBOS DE ASPIRACIÓN FRAZIER-FERGUSON

### PARA SUCCIÓN RECTA

<b>K-25-780</b>	6 Fr (2 mm)
<b>K-25-781</b>	7 Fr (2.3 mm)
<b>K-25-782</b>	8 Fr (2.6 mm)
<b>K-25-783</b>	9 Fr (3 mm)
<b>K-25-784</b>	10 Fr (3.3 mm)
<b>K-25-785</b>	11 Fr (3.6 mm)
<b>K-25-786</b>	12 Fr (4 mm)

### PARA SUCCIÓN ANGULAR

<b>K-25-790</b>	6 Fr (2 mm)
<b>K-25-791</b>	7 Fr (2.3 mm)
<b>K-25-792</b>	8 Fr (2.6 mm)
<b>K-25-793</b>	9 Fr (3 mm)
<b>K-25-794</b>	10 Fr (3.3 mm)
<b>K-25-795</b>	11 Fr (3.6 mm)
<b>K-25-796</b>	12 Fr (4 mm)





**MASTERMED**  
MASTERS EN PRODUCTOS MÉDICOS

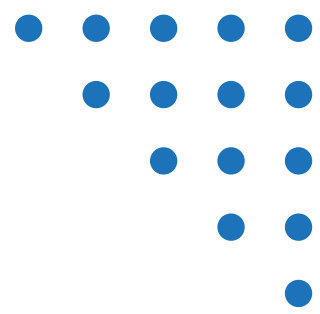

**K-26-561**

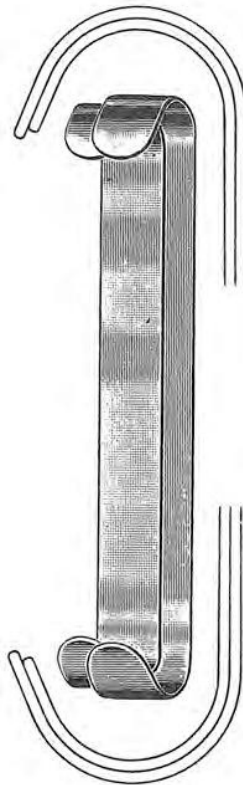

**K-26-563**

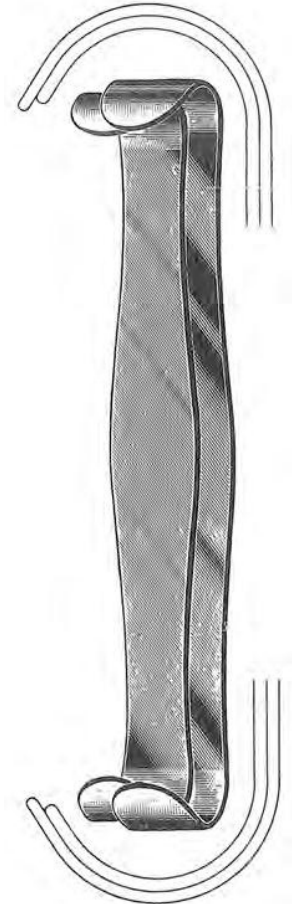

**K-26-563-B**

## SEPARADORES GENERALES

- K-26-561** Separador de GOELET, Doble Punta, 7½" (19.1 cm)
- K-26-563** Separador de PARKER, Juego de Doble Punta, Pequeño, 5" (12.7 cm)
- K-26-563-B** Separador de PARKER, Juego de Doble Punta, Grande, 7¼" (18.4 cm)







**MASTERMED**  
MASTERS EN PRODUCTOS MÉDICOS

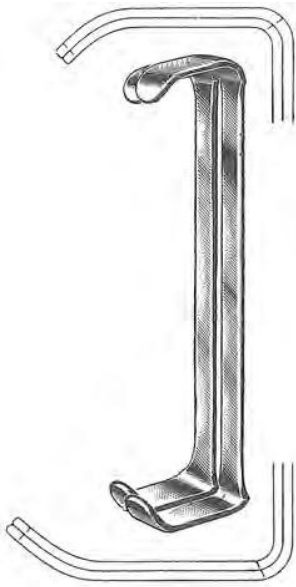
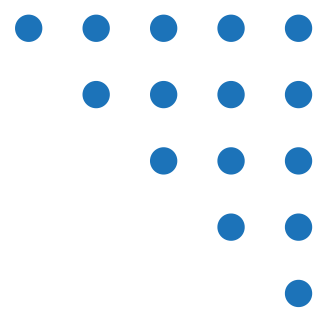

K-26-564-A

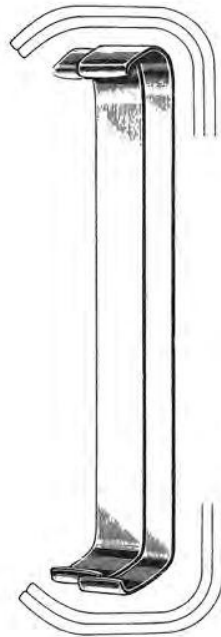

K-26-564  
K-26-565

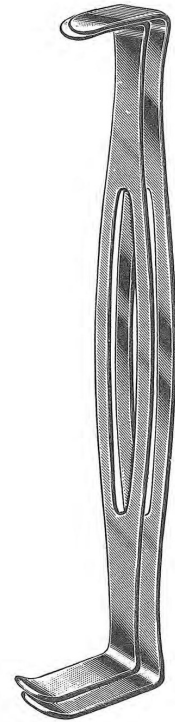

K-26-566

## SEPARADORES GENERALES

- K-26-564-A** Separador de FARABEU, Juego de Doble Punta, "Baby", 4" (10.2 cm)
- K-26-564** Separador de FARABEU, Juego de Doble Punta, Pequeño, 4½" (11.4 cm)
- K-26-565** Separador de FARABEU, Juego de Doble Punta, Grande, 6" (15.2 cm)
- K-26-566** Separador de U.S. ARMY, Juego de Doble Punta, 8½" (21.6 cm)







**MASTERMED**  
MASTERS EN PRODUCTOS MÉDICOS

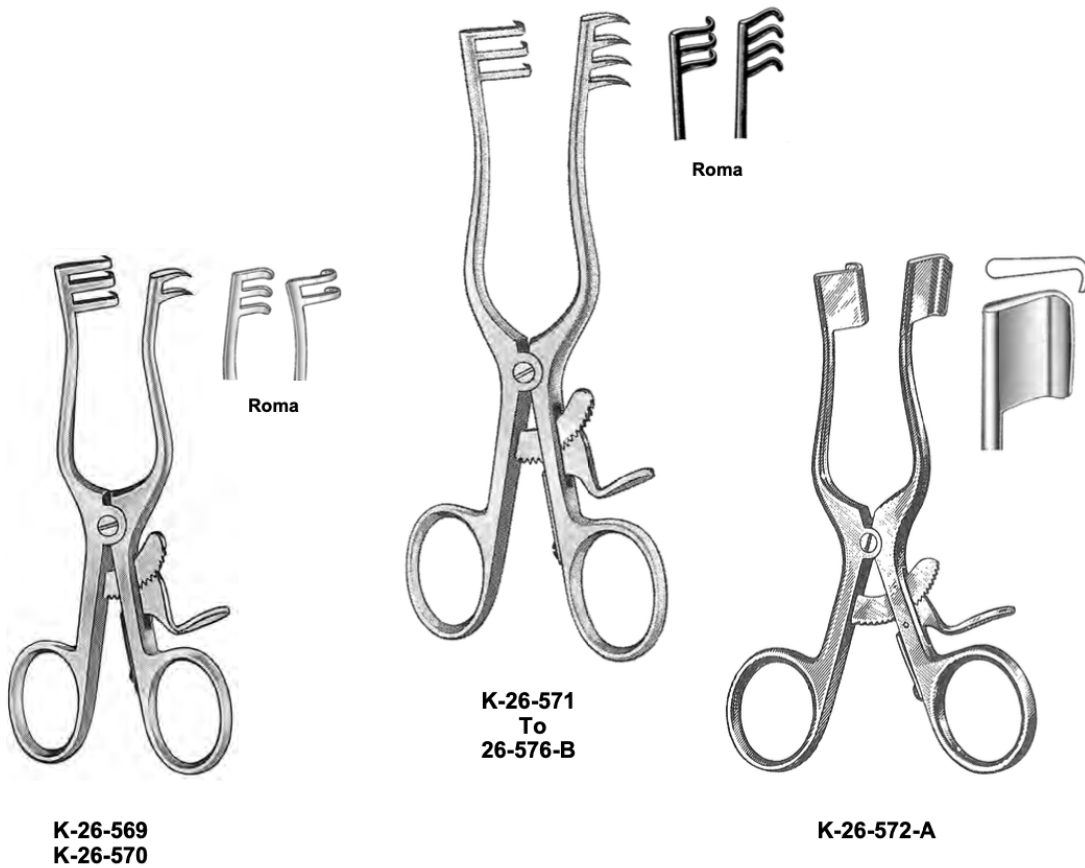

## SEPARADORES GENERALES

- |                   |                                                             |
|-------------------|-------------------------------------------------------------|
| <b>K-26-569</b>   | Separador de WEITLANER, Dientes 2 x 3, Roma, 4" (10.2 cm)   |
| <b>K-26-570</b>   | Separador de WEITLANER, Dientes 2 x 3, Aguda, 4" (10.2 cm)  |
| <b>K-26-571</b>   | Separador de WEITLANER, Dientes 3 x 4, Roma, 5½" (14 cm)    |
| <b>K-26-572</b>   | Separador de WEITLANER, Dientes 3 x 4, Aguda, 5½" (14 cm)   |
| <b>K-26-573</b>   | Separador de WEITLANER, Dientes 3 x 4, Roma, 6½" (16.5 cm)  |
| <b>K-26-574</b>   | Separador de WEITLANER, Dientes 3 x 4, Aguda, 6½" (16.5 cm) |
| <b>K-26-575</b>   | Separador de WEITLANER, Dientes 3 x 4, Roma, 8" (20.3 cm)   |
| <b>K-26-575-A</b> | Separador de WEITLANER, Dientes 3 x 4, Roma, 9½" (24.1 cm)  |
| <b>K-26-576</b>   | Separador de WEITLANER, Dientes 3 x 4, Aguda, 8" (20.3 cm)  |
| <b>K-26-576-A</b> | Separador de WEITLANER, Dientes 3 x 4, Roma, 9½" (24.1 cm)  |
| <b>K-26-576-B</b> | Separador de WEITLANER, Dientes 3 x 4, Aguda, 9½" (24.1 cm) |
| <b>K-26-572-A</b> | Separador de WEITLANER, Hojas Sólidas, 5½" (14 cm)          |



MASTERMED  
MASTERS EN PRODUCTOS MÉDICOS

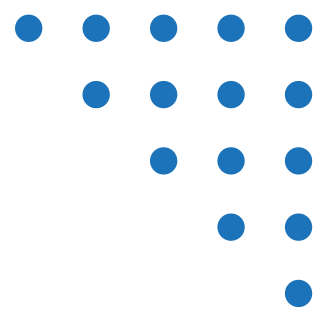

**K-26-577-C**

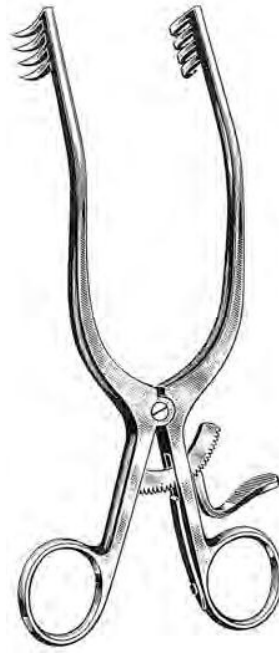

**K-26-577-D**

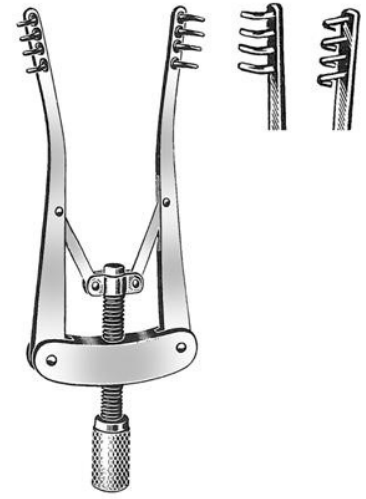

**K-26-577**  
**K-26-578**

## SEPARADORES GENERALES

**K-26-577-C** Separador de ADSON, Brazos Rectos, Dientes 4 x 4, Aguda, 7½" (19 cm)

**K-26-577-D** Separador de ADSON, Brazos Angulares, Dientes 4 x 4, Aguda, 7½" (19 cm)

**K-26-577** Separador de ALM, Autorretenido, Dientes 4 x 4, 2¾" (7 cm)

**K-26-578** Separador de ALM, Autorretenido, Dientes 4 x 4, 4" (10.2 cm)





MASTERMED  
MASTERS EN PRODUCTOS MÉDICOS

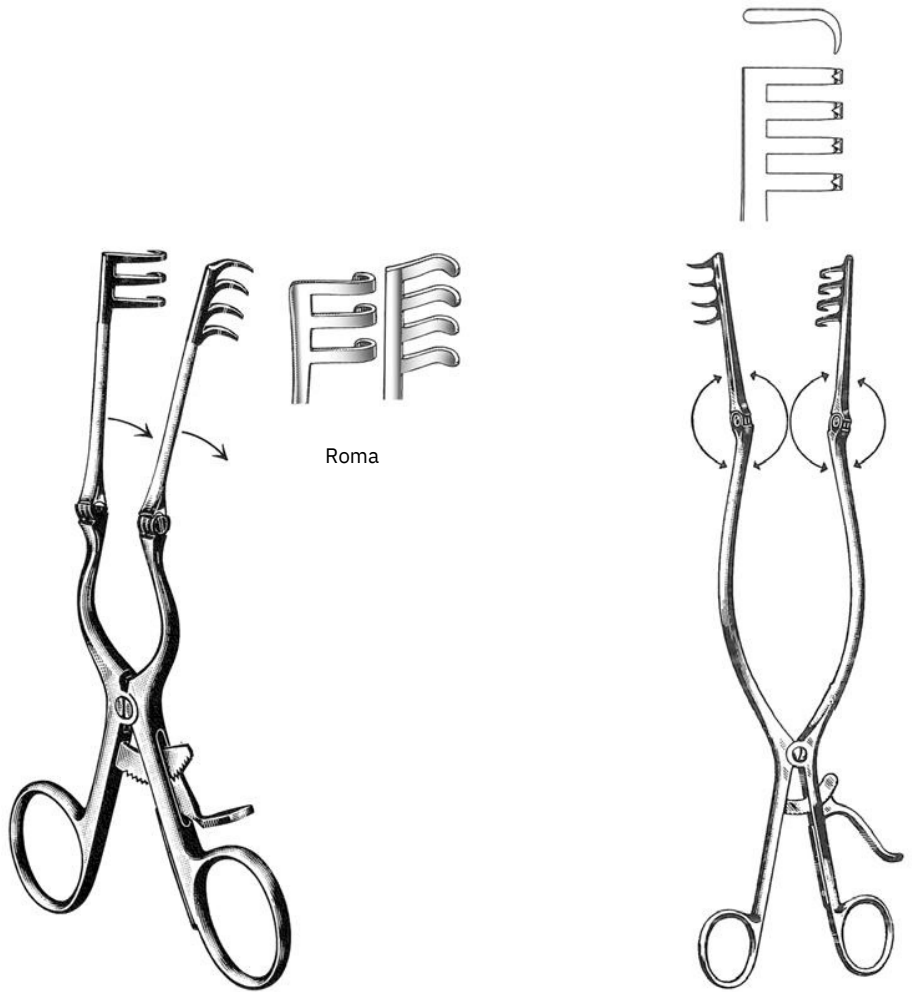

K-26-578-A To  
K-26-578-F

K-26-578-G K-  
26-578-H

## SEPARADORES GENERALES

- K-26-578-A** Separador de BECKMAN, Roma, Dientes 3 x 4, Con brazos articulados, 5½" (14 cm)  
**K-26-578-B** Separador de BECKMAN, Aguda, Dientes 3 x 4, Con brazos articulados, 5½" (14 cm)  
**K-26-578-C** Separador de BECKMAN, Roma, Dientes 3 x 4, Con brazos articulados, 6½" (16.5 cm)  
**K-26-578-D** Separador de BECKMAN, Aguda, Dientes 3 x 4, Con brazos articulados, 6½" (16.5 cm)  
**K-26-578-E** Separador de BECKMAN, Roma, Dientes 3 x 4, Con brazos articulados, 9" (22.9 cm)  
**K-26-578-F** Separador de BECKMAN, Aguda, Dientes 3 x 4, Con brazos articulados, 9" (22.9 cm)
- K-26-578-G** Separador de BECKMAN, Aguda, Dientes 4 x 4, Con brazos articulados, ¾" x 1" (1.9 x 2.5 cm), 12½" (31.8 cm)  
**K-26-578-H** Separador de BECKMAN, Aguda, Dientes 4 x 4, Con brazos articulados, 1¾" x 1¼" (4.5 cm x 3.2 cm), 12½" (31.8 cm)



**MASTERMED**  
MASTERS EN PRODUCTOS MÉDICOS

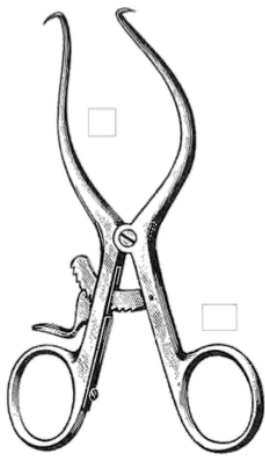
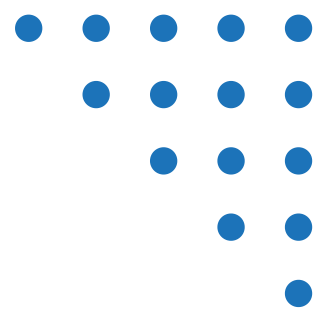

**K-26-581**  
**K-26-581-A**  
**K-26-582**



**K-26-583**

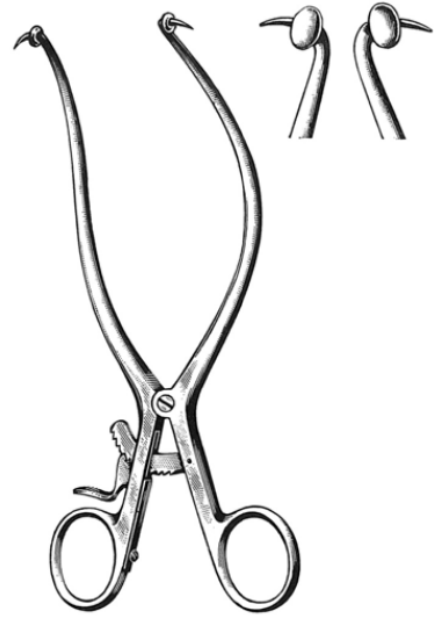

**K-26-584**  
**K-26-585**

## SEPARADORES GENERALES

**K-26-581**  
**K-26-581-A**  
**A K-26-582**

Separador "Baby" de GELPI, Pediátrico, 3½" (8.9 cm)  
Separador "Baby" de GELPI, Pediátrico, 4½" (11.4 cm)  
Separador "Baby" de GELPI, Pediátrico, 5½" (14 cm)

**K-26-583**

Separador de GELPI, 6¾"(17.1 cm)

**K-26-584**  
**K-26-585**

Separador de GELPI, Con Topes, 6¾" (17.1 cm)  
Separador de GELPI, 7½" (19.1 cm)





**MASTERMED**  
MASTERS EN PRODUCTOS MÉDICOS

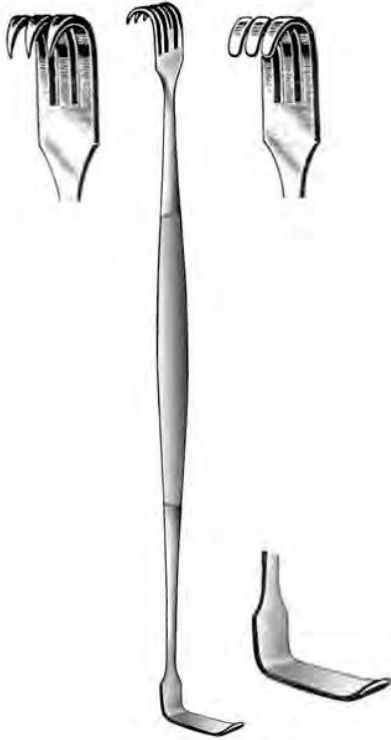

**K-26-586**  
**K-26-587**

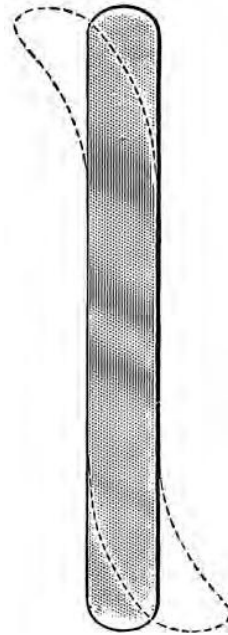

**K-26-610 to**  
**K-26-618**

## SEPARADORES GENERALES

- K-26-586** Separador de SENN (MILLER), con doble punta, 3 Dientes, Aguda, 6¼" (15.9 cm)
- K-26-587** Separador de SENN (MILLER), con doble punta, 3 Dientes, Roma, 6¼" (15.9 cm)
- K-26-610** Separador Maleable de Ribbon, ¾ x 13" (2 x 33 cm)
- K-26-611** Separador Maleable de Ribbon, 1 x 13" (2.5 x 33 cm)
- K-26-612** Separador Maleable de Ribbon, 1¼ x 13" (3.2 x 33 cm)
- K-26-613** Separador Maleable de Ribbon, 1½ x 13" (3.8 x 33 cm)
- K-26-614** Separador Maleable de Ribbon, 1¾ x 13" (4.4 x 33 cm)
- K-26-615** Separador Maleable de Ribbon, 2 x 13" (5 x 33 cm)
- K-26-616** Separador Maleable de Ribbon, 2½ x 13" (6.4 x 33 cm)
- K-26-617** Separador Maleable de Ribbon, 2¾ x 13" (7 x 33 cm)
- K-26-618** Separador Maleable de Ribbon, 3 x 13" (7.6 x 33 cm)

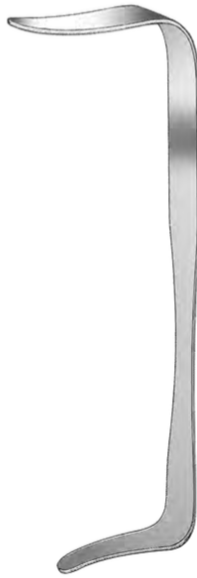
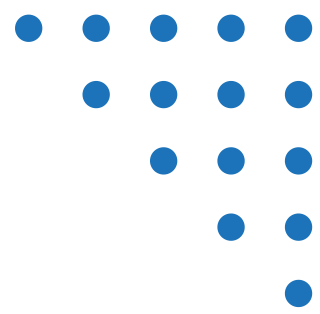

**K-26-620**



**K-26-640**



**K-26-643**



**K-26-645**

## SEPARADORES GENERALES

- K-26-620** Separador Abdominal DEEVER, 1 x 9" (2.5 x 22.9 cm)
- K-26-640** Separador Abdominal DEEVER, Pediátrico, 5/8 x 8 1/2" (1.6 x 21.6 cm)
- K-26-643** Separador Abdominal DEEVER, Pediátrico, 3/4 x 7" (2 x 17.8 cm)
- K-26-645** Separador Abdominal DEEVER, Pediátrico, 7/8 x 8" (2.2 x 20.3 cm)



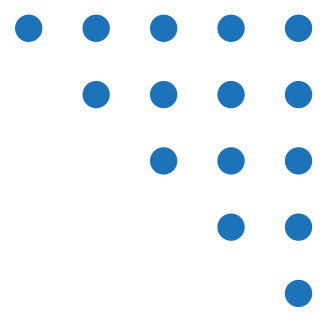

**K-26-623**  
**K-26-625**



**K-26-628**



**K-26-630**  
**K-26-635**

## SEPARADORES GENERALES

- |                 |                                                      |
|-----------------|------------------------------------------------------|
| <b>K-26-623</b> | Separador Abdominal DEEVER, 1 x 12" (2.5 x 30.5 cm)  |
| <b>K-26-625</b> | Separador Abdominal DEEVER, 1 x 13" (2.5 x 33 cm)    |
| <b>K-26-628</b> | Separador Abdominal DEEVER, 1½ x 12" (3.8 x 30.5 cm) |
| <b>K-26-630</b> | Separador Abdominal DEEVER, 2 x 12" (5.1 x 30.5 cm)  |
| <b>K-26-635</b> | Separador Abdominal DEEVER, 3 x 13" (7.6 x 33 cm)    |







**MASTERMED**  
MASTERS EN PRODUCTOS MÉDICOS

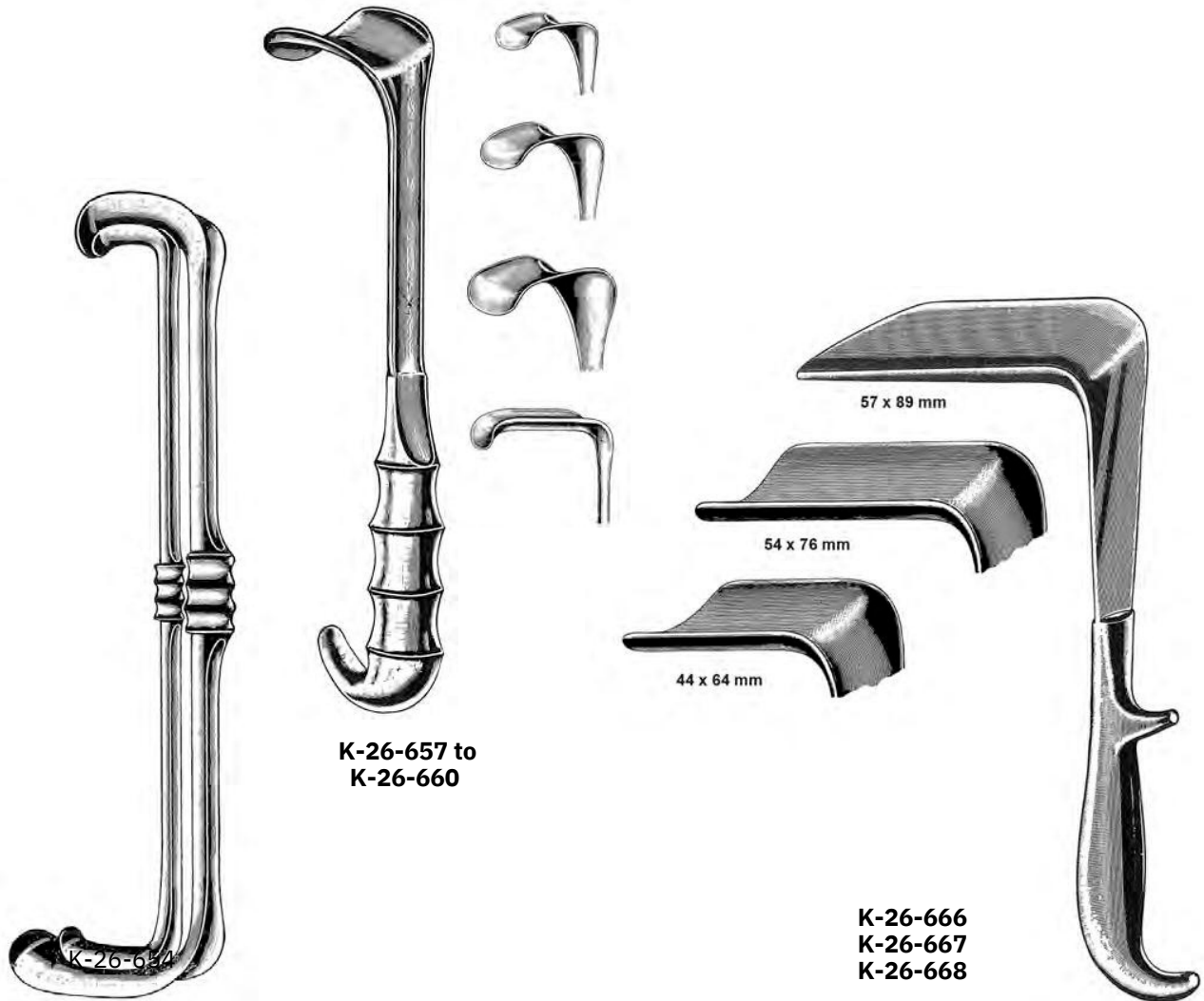

## SEPARADORES GENERALES

- K-26-654** Separador RICHARDSON-EASTMAN, Juego de 2 Pzas
- K-26-657** Separador RICHARDSON, 1" x ¾" (2.5 x 2 cm), 9½" (24.1 cm)  
**K-26-658** Separador RICHARDSON, 1¼" x 1" (3.2 x 2.5 cm), 9½" (24.1 cm)  
**K-26-659** Separador RICHARDSON, 1½" x 1" (3.8 x 2.5 cm), 9½" (24.1 cm)  
**K-26-660** Separador RICHARDSON, 2" x ¾" (5.1 x 2 cm), 9½" (24.1 cm)
- K-26-666** Valva Vaginal de DOYEN, Pequeño, 1¾" x 2½" (4.4 x 6.4 cm), 9" (22.9 cm)  
**K-26-667** Valva Vaginal de DOYEN, Mediana, 2½" x 3" (6.4 x 7.6 cm), 9" (22.9 cm)  
**K-26-668** Valva Vaginal de DOYEN, Grande, 2¼" x 3½" (5.7 x 8.9 cm), 9" (22.9 cm)





MASTERMED  
MASTERS EN PRODUCTOS MÉDICOS

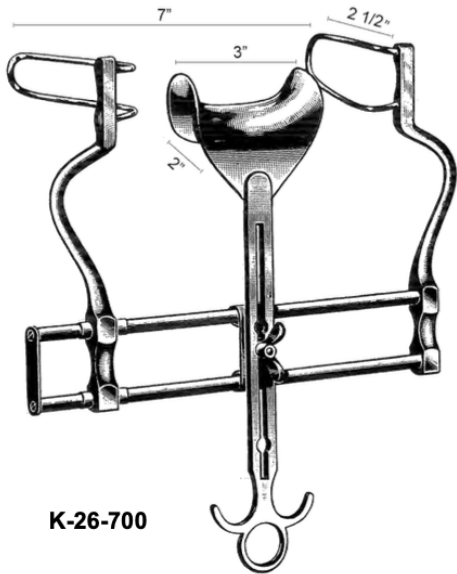

**K-26-700**

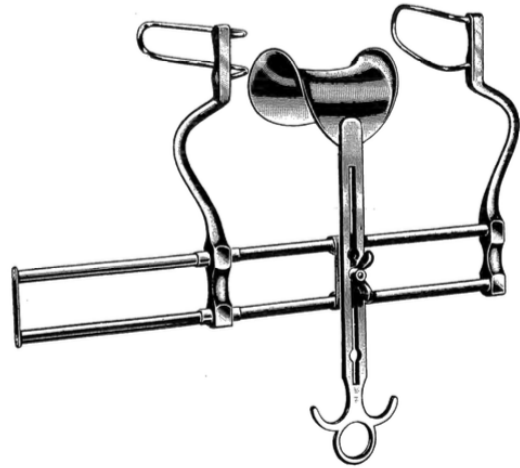

**K-26-701**

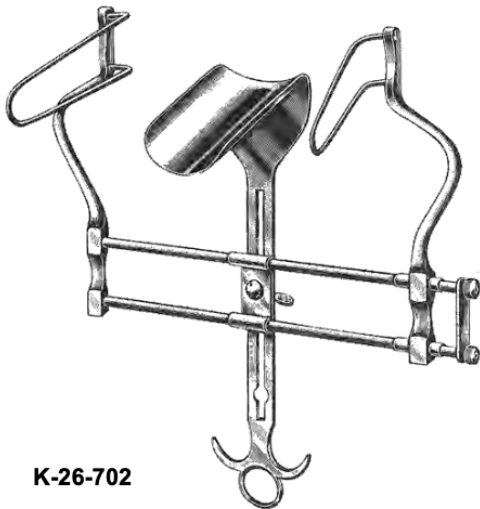

**K-26-702**

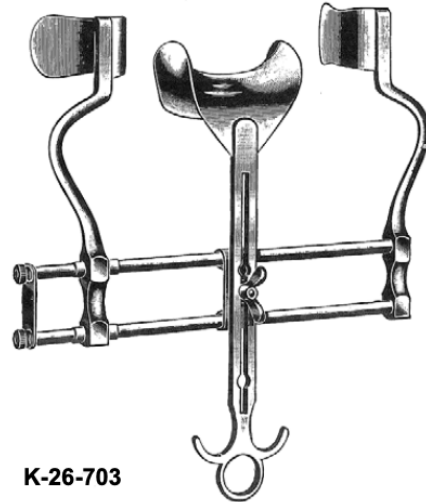

**K-26-703**

## SEPARADORES GENERALES

- K-26-700** Separador BALFOUR, con Valvas Fenestradas de 2 1/2" (6.4 cm) de largo, Apertura Máxima de 7" (17.8 cm)
- K-26-701** Separador BALFOUR, con Valvas Fenestradas de 2 1/2" (6.4 cm) de largo, Apertura Máxima de 10" (25.4 cm)
- K-26-702** Separador BALFOUR, con Valvas Fenestradas de 4" (10.2 cm) de largo, Apertura Máxima de 7" (17.8 cm)
- K-26-703** Separador BALFOUR, con Valvas Sólidas de 3" (7.6 cm) de largo, Apertura Máxima de 7" (17.8 cm)

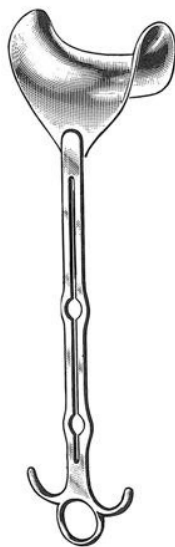
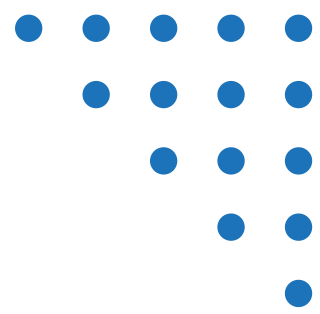

**K-26-703-A**

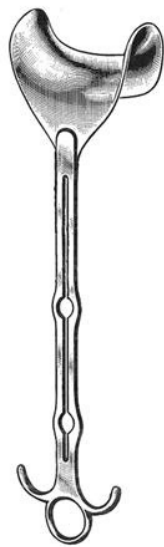

**K-26-703-B**

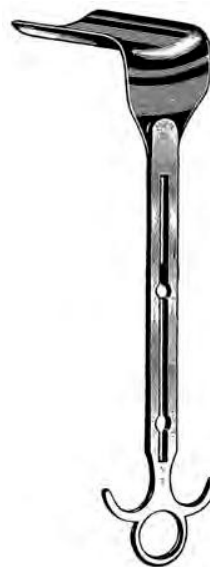

**K-26-703-C**

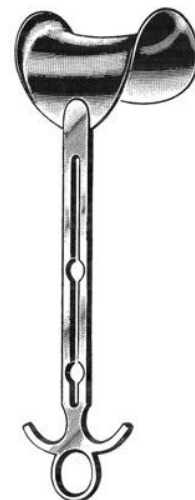

**K-26-704**

## SEPARADORES GENERALES

- K-26-703-A** Valva Central para BALFOUR, Estandar, 3" x 1¾" (7.6 x 4.4 cm) de largo
- K-26-703-B** Valva Central para BALFOUR, Estandar, 3" x 2" (4.6 x 5 cm) de largo
- K-26-703-C** Valva Central para BALFOUR, Estandar, 2¾" x 4" (7 cm x 10.2 cm) de Extra Largo
- K-26-704** Valva Central para BALFOUR, Supra Pubica, 3¼" x 2¾" (8.3 cm x 7 cm) Largo





**MASTERMED**  
MASTERS EN PRODUCTOS MÉDICOS

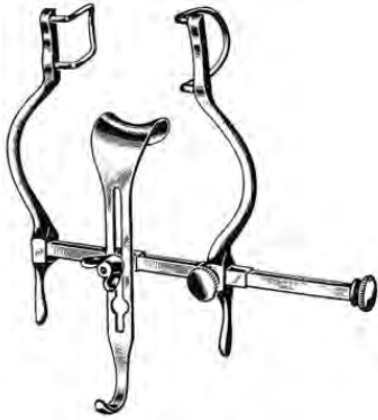

**K-26-705**

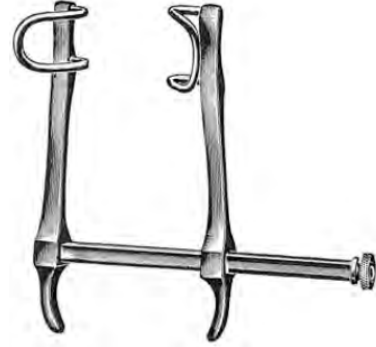

**K-26-709**

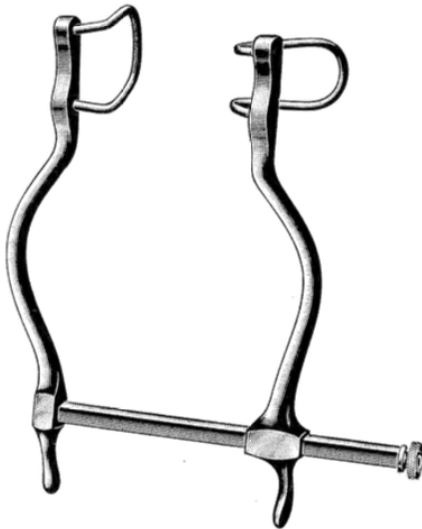

**K-26-707**  
**K-26-708**

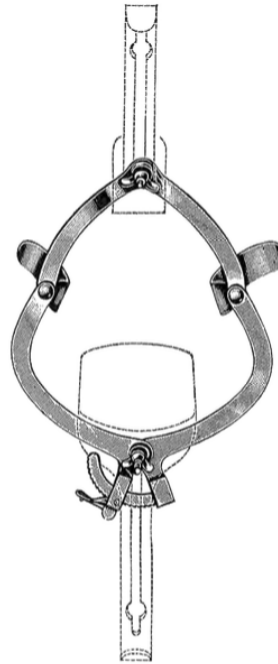

**K-26-710**



## SEPARADORES GENERALES

- K-26-705** Separador de BALFOUR, Pediátrico con Valvas Fenestradas Apertura Máxima de 4" (10.2 cm)
- K-26-707** Separador de GOSSETT, con Apertura Máxima de 4" (10.2 cm)  
**K-26-708** Separador de GOSSETT, con Apertura Máxima de 5½" (14 cm)
- K-26-709** Separador de GOSSETT, Pediátrico, con Apertura Máxima de 3½" (8.9 cm)
- K-26-710** Separador Abdominal O'SULLIVAN-O'CONNOR, con 3 Valvas intercambiables

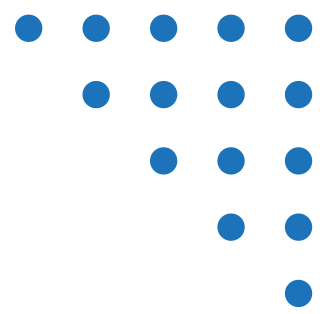

K-26-711

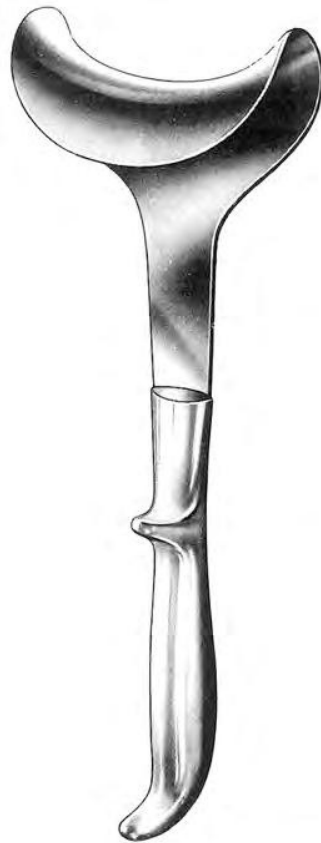

K-26-713

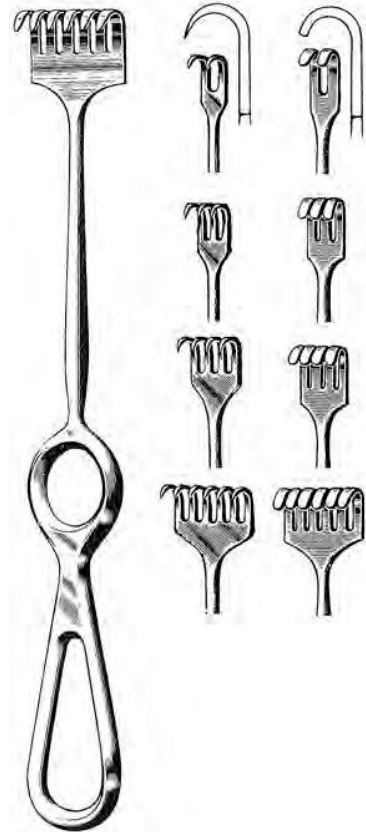

K-26-715  
to  
K-26-723

## SEPARADORES GENERALES

- K-26-711** Separador Abdominal MAYO, Hoja 2¾" (7 cm) de ancho, 10" (25.4 cm)
- K-26-713** Separador Abdominal DOYEN, Hoja 50 mm x 85 mm, 10" (25.4 cm)
- K-26-715** Separador de VOLKMAN, con 2 Dientes, Aguda, 8¾" (22.2cm)
- K-26-716** Separador de VOLKMAN, con 3 Dientes, Aguda, 8¾" (22.2cm)
- K-26-717** Separador de VOLKMAN, con 4 Dientes, Aguda, 8¾" (22.2cm)
- K-26-718** Separador de VOLKMAN, con 6 Dientes, Aguda, 8¾" (22.2cm)
- K-26-720** Separador de VOLKMAN, con 2 Dientes, Roma, 8¾" (22.2cm)
- K-26-721** Separador de VOLKMAN, con 3 Dientes, Roma, 8¾" (22.2cm)
- K-26-722** Separador de VOLKMAN, con 4 Dientes, Roma, 8¾" (22.2cm)
- K-26-723** Separador de VOLKMAN, con 6 Dientes, Roma, 8¾" (22.2cm)



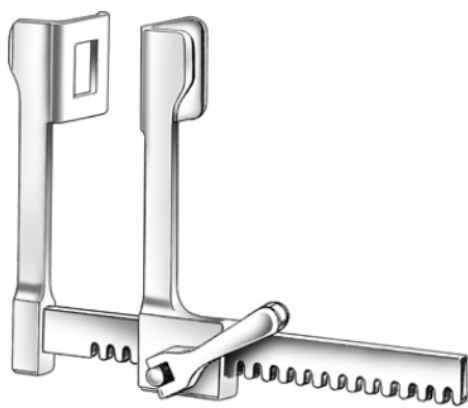

**GS-55-680**

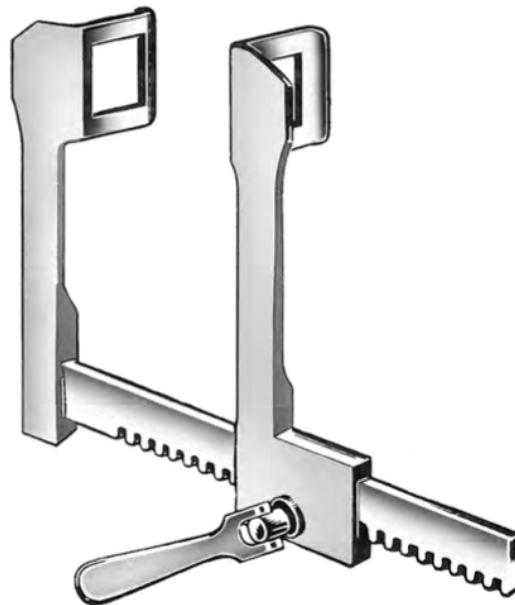

**GS-55-682  
to  
GS-55-688**

## SEPARADORES GENERALES

- GS-55-680** Separador de FINOCHIETTO-DEBAKEY, Infantil, Apertura Máxima 3½" (8.5 cm), con Brazo Recto, (Crown Code 661-200)
- GS-55-682** Separador de FINOCHIETTO-DEBAKEY, Infantil, Apertura Máxima 6" (15.2 cm), con Brazo Recto (Crown Code 661-203)
- GS-55-684** Separador de FINOCHIETTO, Estandar, Apertura Máxima 8" (20.3 cm), con Brazo Recto (Crown Code 661-204)
- GS-55-686** Separador de FINOCHIETTO, Estandar, Apertura Máxima 10" (25.4 cm), con Brazo Recto (Crown Code 661-205)
- GS-65-688** Separador de FINOCHIETTO, Estandar, Apertura Máxima 12" (30.5 cm), con Brazo Recto (Crown Code 661-206)

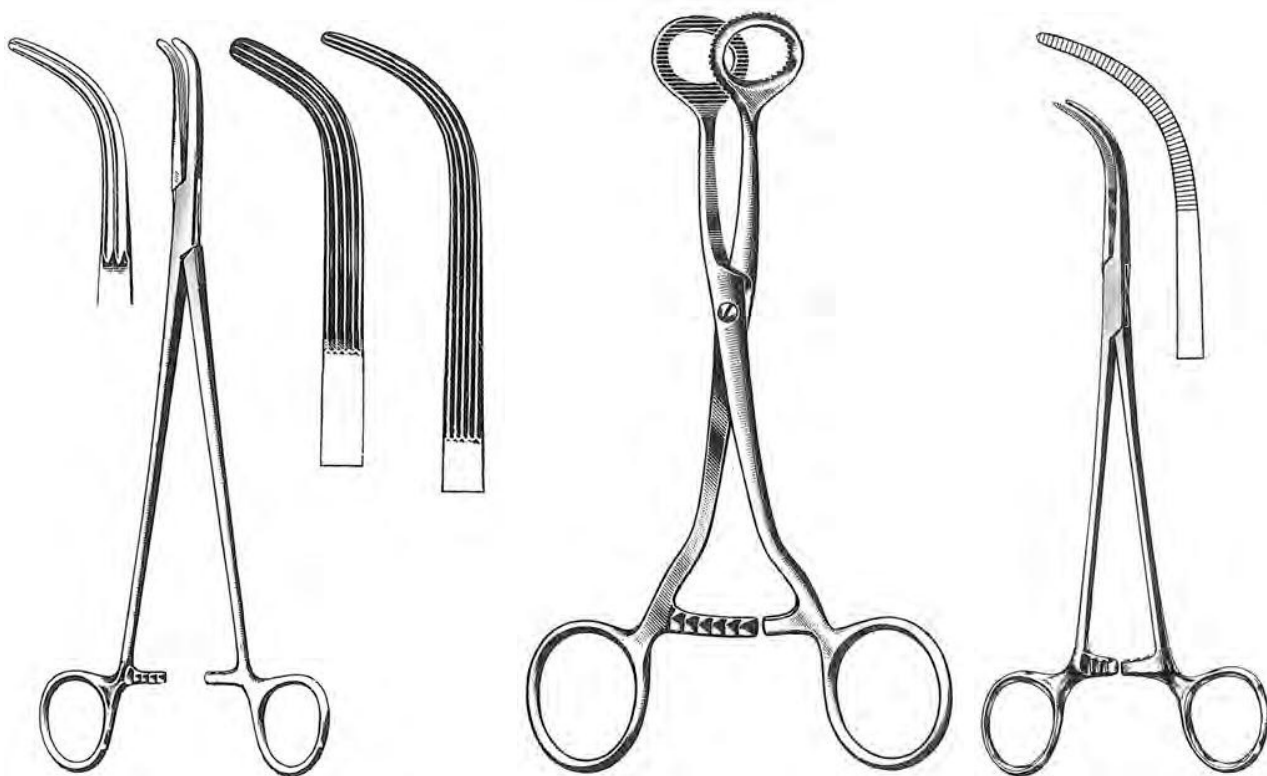
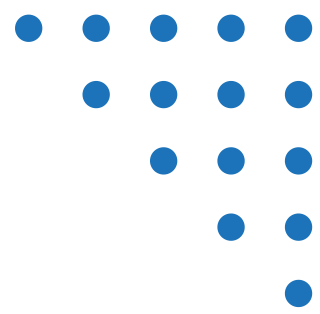

**K-26-735**  
**K-26-736**  
**K-26-737**

**K-26-740**

**K-26-750**

## INSTRUMENTOS PARA CÁLCULOS BILIARES

- K-26-735** Pinza Vesicular LAHEY, Borde Longitudinal, Mandibula Curva, 4½" (19.1 cm)
- K-26-736** Pinza Vesicular LAHEY, Borde Longitudinal, Mandibula Curva, 9" (22.9 cm)
- K-26-737** Pinza Vesicular LAHEY, Borde Longitudinal, Mandibula Curva, 11" (27.9 cm)
- K-26-740** Pinza Vesicular COLLIN (JUDD-DeMARTEL), Borde Longitudinal, 6" (15.2 cm)
- K-26-750** Pinza Cistica GREEN, Curva Completa, 8¾" (21.6 cm)





MASTERMED  
MASTERS EN PRODUCTOS MÉDICOS

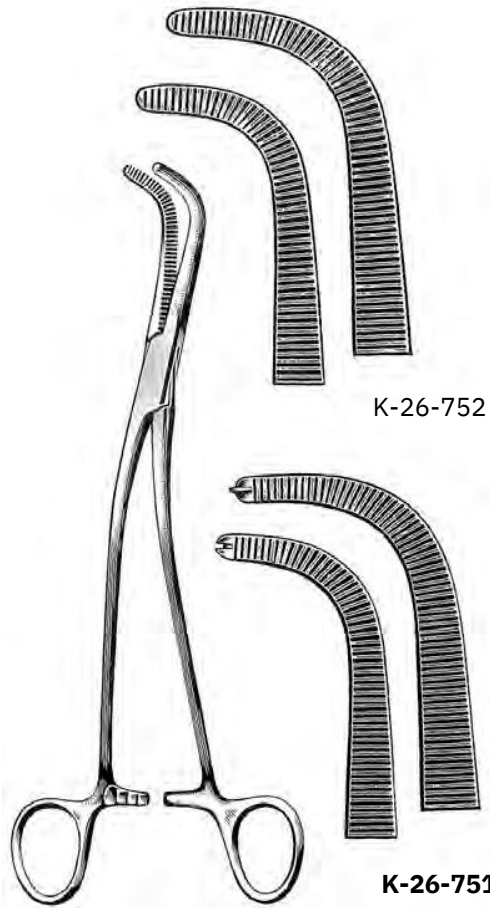

**K-26-751**  
**K-26-752**

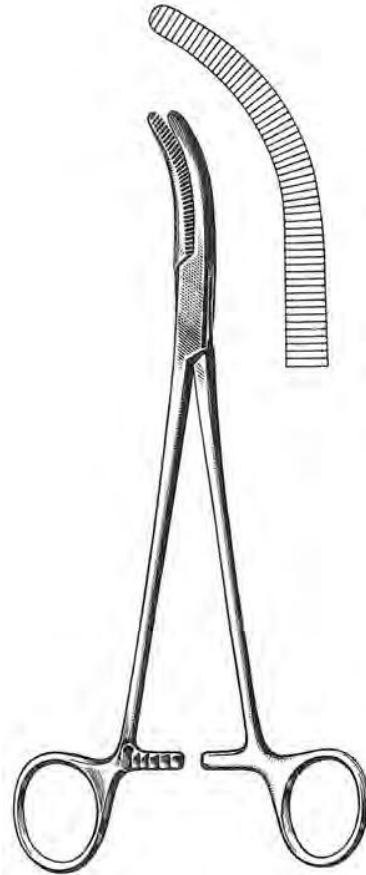

**K-26-755**

## INSTRUMENTOS PARA CÁLCULOS BILIARES

**K-26-751** Pinza Cística GRAY, Serrada, Dientes 1 x 2, set de dos, 9" (22.9 cm)

**K-26-752** Pinza Cística GRAY, Serrada, set de 2, 9" (22.9 cm)

**K-26-755** Pinza Vesicular MOYNIHAN, Ligeramente curvada, 8½" (21.6 cm),



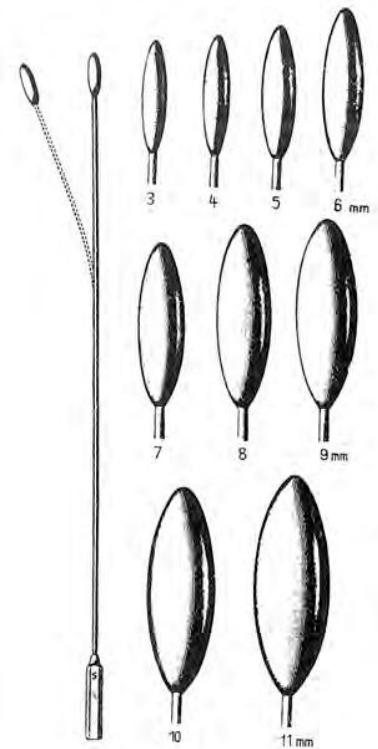
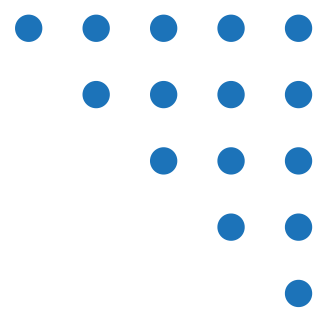

**K-26-760**

## INSTRUMENTOS PARA CÁLCULOS BILIARES

**K-26-760** Set de 9 dilatadores BAKES, para Vías Biliares , de 3 a 11 mm maleables





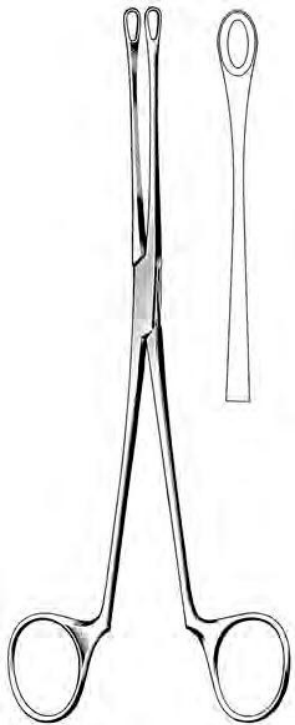
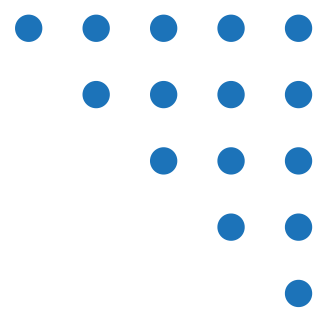

K-26-775



K-26-776

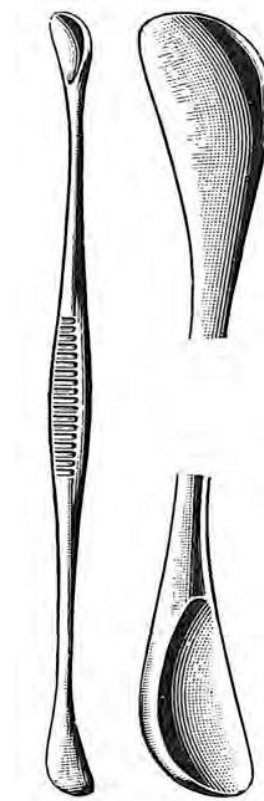

K-26-780  
K-26-781  
K-26-782

## INSTRUMENTOS PARA CALCULOS BILIARES

- K-26-775** Pinza BLAKES, para Piedras Biliares, Recta, 8½" (21.6 cm)  
**K-26-776** Pinza BLAKES, para Piedras Biliares, Curva, 8½" (21.6 cm)  
**K-26-780** FERGUSON, Cucharilla para piedras Biliares, doble punta, Pequeño, 9½" (24.1 cm)  
**K-26-781** FERGUSON, Cucharilla para piedras Biliares, doble punta, Mediano, 9½" (24.1 cm)  
**K-26-782** FERGUSON, Cucharilla para piedras Biliares, doble punta, Grande, 9½" (24.1 cm)





**MASTERMED**  
MASTERS EN PRODUCTOS MÉDICOS

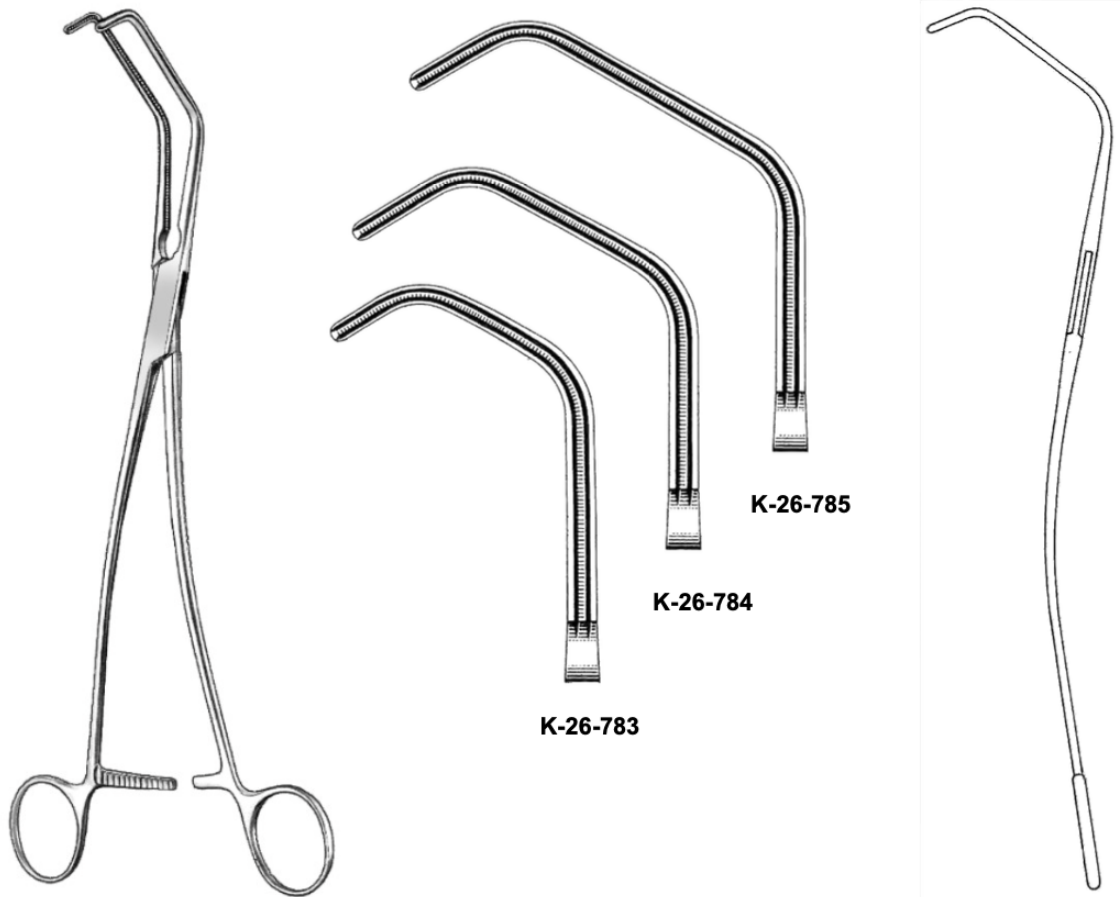
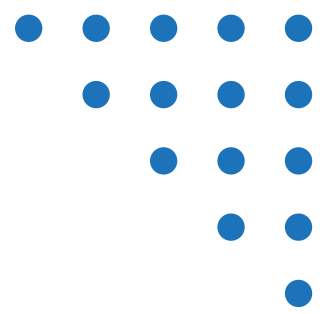

**K-26-783**  
**K-26-784**  
**K-26-785**

## INSTRUMENTAL CARDIOVASCULAR ATRAUMÁTICO

- K-26-783** Pinza SATINSKY-DEBAKEY, para Vena Cava, Pequeño, 9¾" (24.8 cm)
- K-26-784** Pinza SATINSKY-DEBAKEY, para Vena Cava, Mediano, 9¾" (24.8 cm)
- K-26-785** Pinza SATINSKY-DEBAKEY, para Vena Cava, Grande, 9¾" (24.8 cm)





**MASTERMED**  
MASTERS EN PRODUCTOS MÉDICOS



**GS-55-670**

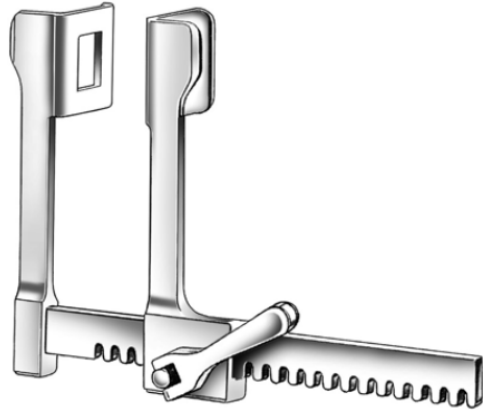

**GS-55-680**

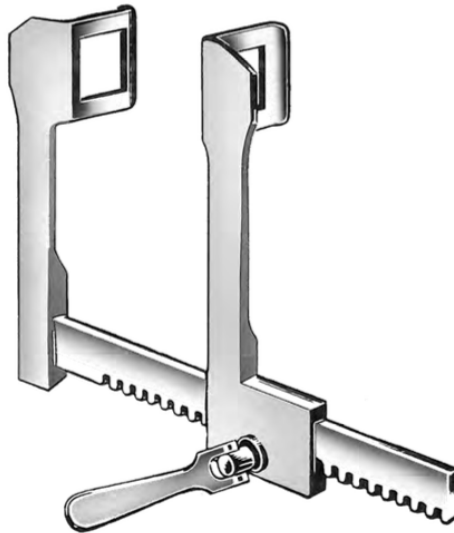

**GS-55-682  
to  
GS-55-688**

## INSTRUMENTAL CARDIOVASCULAR ATRAUMÁTICO

- GS-55-670** Pinza Arterial SAROT (CRAFOORD) Torácica, 9½" (24.1 cm)
- GS-55-680** Separador de FINOCHIETTO-DeBAKEY, Infantil, Apertura Máxima 3½" (8.5 cm), con Brazo Recto, (Crown Code 661-200)
- GS-55-682** Separador de FINOCHIETTO-DeBAKEY, Infantil, Apertura Máxima 6" (15.2 cm), con Brazo Recto (Crown Code 661-203)
- GS-55-684** Separador de FINOCHIETTO, Estandar, Apertura Máxima 8" (20.3 cm), con Brazo Recto (Crown Code 661-204)
- GS-55-686** Separador de FINOCHIETTO, Estandar, Apertura Máxima 10" (25.4 cm), con Brazo Recto (Crown Code 661-205)
- GS-65-688** Separador de FINOCHIETTO, Estandar, Apertura Máxima 12" (30.5 cm), con Brazo Recto (Crown Code 661-206)



**MASTERMED**  
MASTERS EN PRODUCTOS MÉDICOS

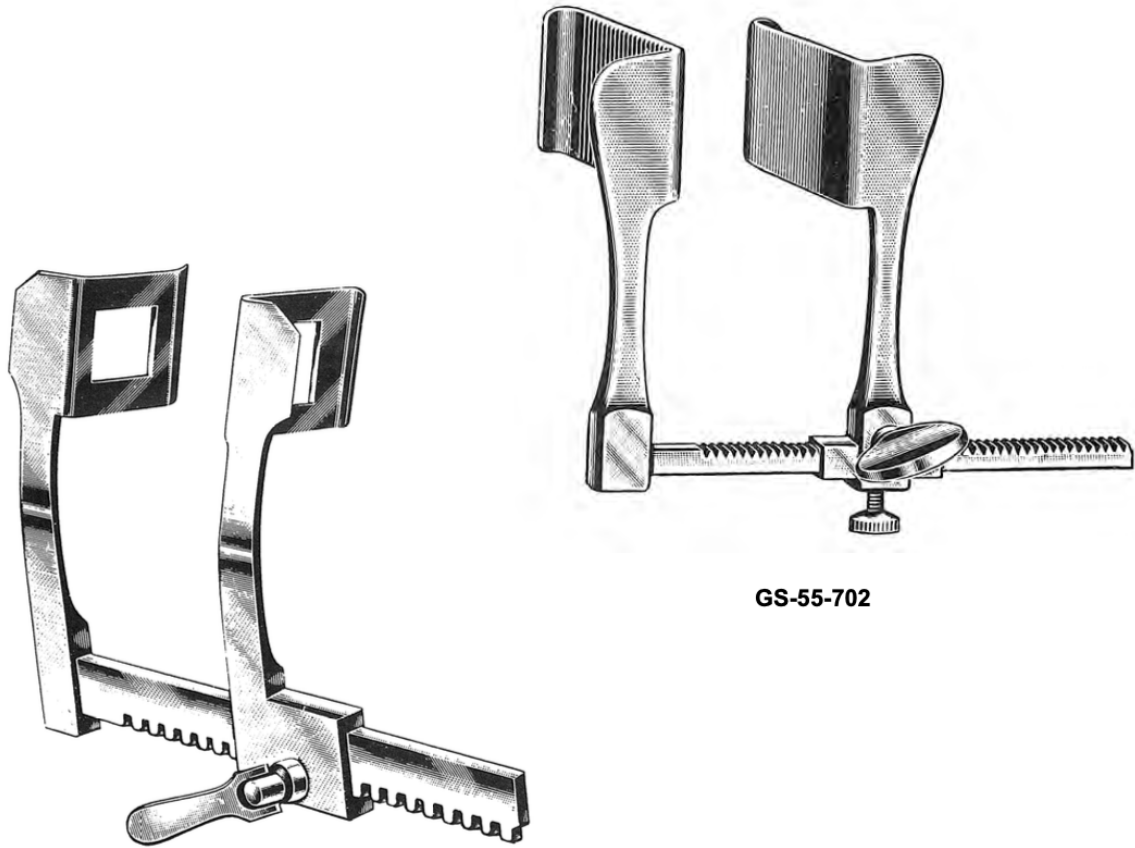
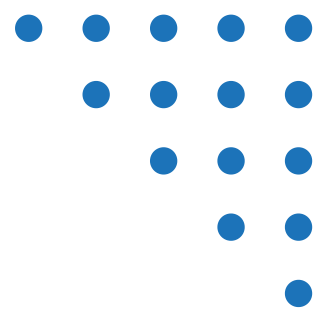

**GS-55-689**  
to  
**GS-55-694**

**GS-55-702**

## INSTRUMENTAL CARDIOVASCULAR ATRAUMÁTICO

**GS-55-689** Separador de FINOCHIETTO, Curvo, con Apertura Máxima de 6" (15.2 cm)  
(Crown Code 662-052)

**GS-55-690** Separador de FINOCHIETTO, Curvo, con Apertura Máxima de 8" (20.3 cm)  
(Crown Code 662-054)

**GS-55-692** Separador de FINOCHIETTO, Curvo, con Apertura Máxima de 10" (25.4 cm)  
(Crown Code 662-056)

**GS-55-694** Separador de FINOCHIETTO, Curvo, con Apertura Máxima de 12" (30.5 cm)  
(Crown Code 662-106)

GS-55-702 Retractor TUFFIER, Hojas 2" x 1¾" (5.1 cm x 4.4 cm), Expansion 6½" (16.5 cm)





**MASTERMED**  
MASTERS EN PRODUCTOS MÉDICOS



**K-27-730**  
**K-27-732**



**K-27-734**



**K-27-736**

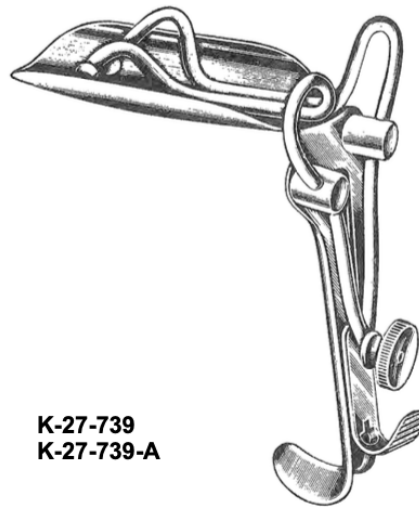

**K-27-739**  
**K-27-739-A**

## INSTRUMENTAL PARA GINECOLOGÍA

- K-27-730** Espéculo Vaginal de GRAVES, Virgen, Estrecho,  $\frac{9}{16}$  x 3" (1.4 x 7.6 cm)  
**K-27-732** Espéculo Vaginal de GRAVES, Pequeño,  $\frac{3}{4}$  x 3" (1.9 x 7.6 cm)  
**K-27-734** Espéculo Vaginal de GRAVES, Mediano,  $1\frac{1}{8}$  x 4" (3.5 x 10 cm)  
**K-27-736** Espéculo Vaginal de GRAVES, Grande,  $1\frac{1}{2}$  x  $4\frac{1}{2}$ " (3.8 x 11.4 cm)
- K-27-739** Espéculo Vaginal de GUTTMAN, Autorretenido, Estandar, para examación,  $1\frac{3}{8}$  x 4" (3.5 x 10 cm)  
**K-27-739-A** Espéculo Vaginal de GUTTMAN, Autorretenido, para examación, 3" x  $1\frac{3}{4}$ " (7.6 cm x 4.5 cm)



**MASTERMED**  
MASTERS EN PRODUCTOS MÉDICOS



**K-27-749**

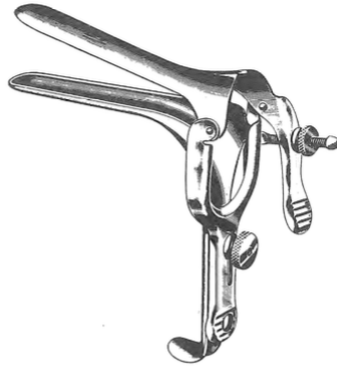

**K-27-750**



**K-27-751**

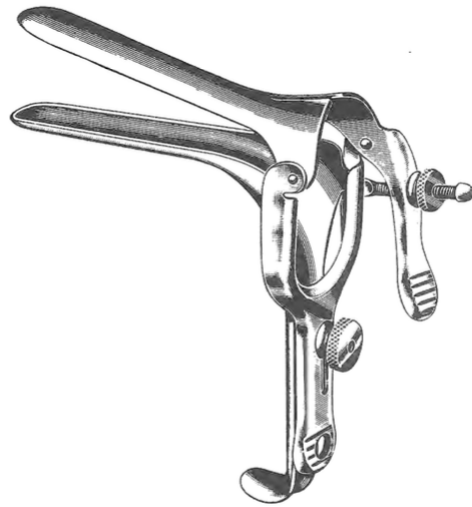

**K-27-752**

## INSTRUMENTAL PARA GINECOLOGÍA

- K-27-749**    Espéculo Vaginal de PEDERSON, Virgen, Estrecho,  $\frac{3}{8}$  x 3" (1.0 cm x 7.6 cm)
- K-27-750**    Espéculo Vaginal de PEDERSON, Pequeño,  $\frac{1}{2}$  x 3" (1.3 x 7.6 cm)
- K-27-751**    Espéculo Vaginal de PEDERSON, Mediano,  $\frac{7}{8}$  x 4" (2.2 x 10 cm)
- K-27-752**    Espéculo Vaginal de PEDERSON, Grande, 1 x  $4\frac{3}{4}$ " (2.5 x 12 cm)



**MASTERMED**  
MASTERS EN PRODUCTOS MÉDICOS

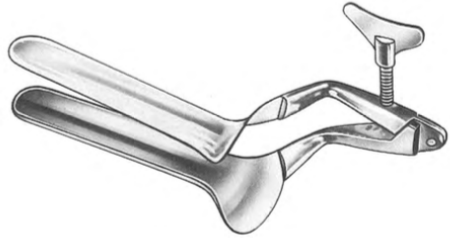

**K-27-760-A**

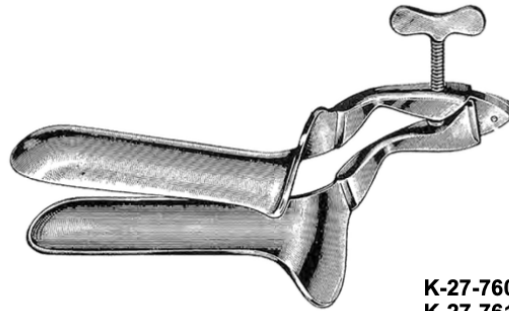

**K-27-760**  
**K-27-761**  
**K-27-762**



**K-27-771**  
**K-27-771-A**  
**K-27-771-B**

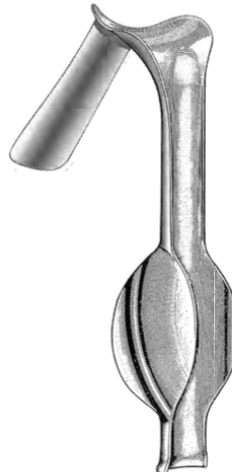

**K-27-771-C**

## INSTRUMENTAL PARA GINECOLOGIA

- K-27-760-A** Espéculo Vaginal de COLLIN, Virgen, 1 x ¼ x 3¾" (3.2 x 9.5 cm)
- K-27-760** Espéculo Vaginal de COLLIN, Pequeño, 1 x ¼ x 3¾" (3.2 x 9.5 cm)
- K-27-761** Espéculo Vaginal de COLLIN, Mediano, 1⅜" x 4" (3.5 x 10 cm)
- K-27-762** Espéculo Vaginal de COLLIN, Grande, 1⅝" x 4½" (4.1 x 11.4 cm)
- K-27-771** Valva Vaginal de AUVARD, Peso de 2 lbs (909 gr)
- K-27-771-A** Valva Vaginal de AUVARD, Peso de 2.5 lbs (1136 gr)
- K-27-771-B** Valva Vaginal de AUVARD, Peso de 3 lbs (1363 gr)
- K-27-771-C** Valva Vaginal de AUVARD, Peso de 2.5 lbs Angulada (1136 gr)





**MASTERMED**  
MASTERS EN PRODUCTOS MÉDICOS

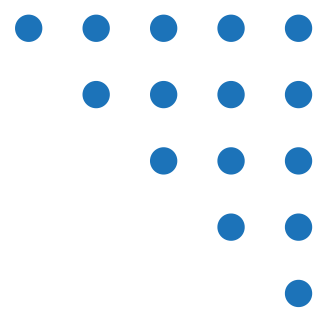

K-27-772  
K-27-772-A

K-27-772-B  
K-27-772-C

## INSTRUMENTAL PARA GINECOLOGÍA

- K-27-772** Espéculo KOGAN, Endocervical, 3 mm, Con Tornillo Dorado, 9½" (24.1 cm)  
**K-27-772-A** Espéculo KOGAN, Endocervical, 7 mm, Con Tornillo Dorado, 9½" (24.1 cm)  
**K-27-772-B** Espéculo KOGAN, Endocervical, 3 mm, Con Cremallera Dorado, 9½" (24.1 cm)  
**K-27-772-C** Espéculo KOGAN, Endocervical, 7 mm, Con Cremallera Dorado, 9½" (24.1 cm)







MASTERMED  
MASTERS EN PRODUCTOS MÉDICOS

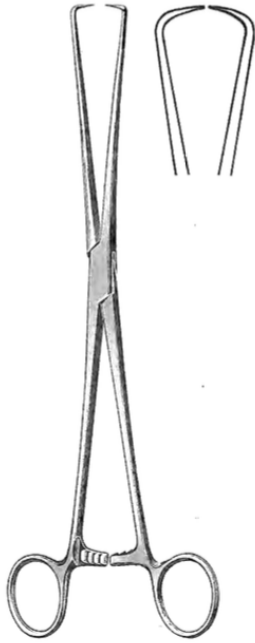

**K-27-774**



**K-27-776**



**K-27-781**



**K-27-781-A**

## PINZAS UTERINAS

- K-27-774** Pinza Uterina de BRAUN, Recta, 9½" (24.1 cm)
- K-27-776** Pinza Uterina de SCHROEDER (POZZI), Recta, 9½" (24.1 cm)
- K-27-781** Pinza Uterina JACOBS, Dientes de 2 x 2, Recta, 8½" (22.2 cm)
- K-27-781-A** Pinza Uterina JACOBS (MUSEUX), Dientes de 2 x 2, Curva, 8½" (22.2 cm)



**MASTERMED**  
MASTERS EN PRODUCTOS MÉDICOS

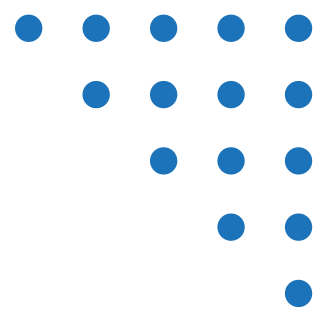

**K-27-782-B**

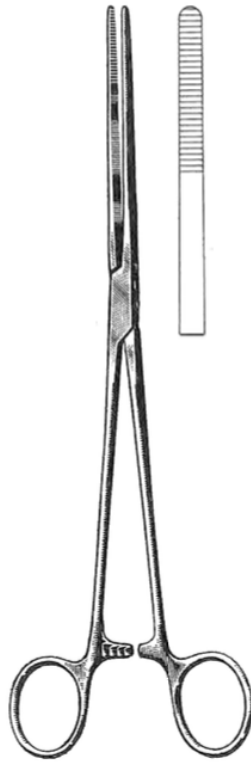

**K-27-783**



**K-27-784**

## PINZAS UTERINAS

- K-27-782-B** Amniotomo de BEACHAM, 10¼" (26 cm)
- K-27-783** Pinza Uterina BOZEMAN, Recta, 10½" (26.7 cm).
- K-27-784** Pinza Uterina BOZEMAN, Doble Curva, 10½" (26.7 cm)





**MASTERMED**  
MASTERS EN PRODUCTOS MÉDICOS

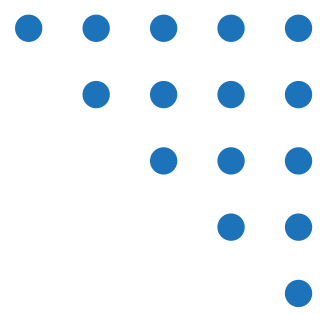

**K-27-790**

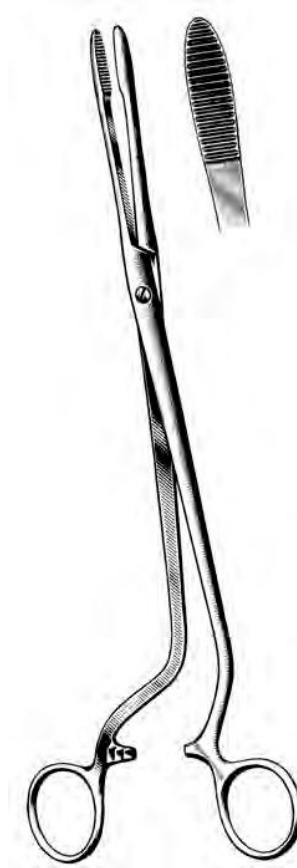

**K-14-258**



**K-14-260**

## PINZAS UTERINAS

- K-27-790** Histerómetro Uterino de SIMS, Graduado en cm, maleable, 13" (33 cm)
- K-14-258** Pinza Uterina CHERON, Angulada hacia un lado, 10½" (26.7 cm)
- K-14-260** Pinza Uterina MAIER, con Mandibulas giratorias, Recta, 10" (25.4 cm)



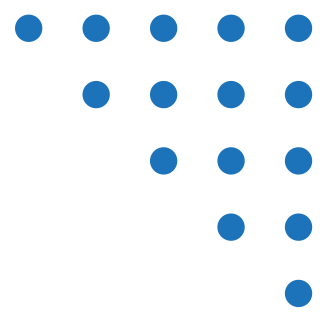

**K-27-794**

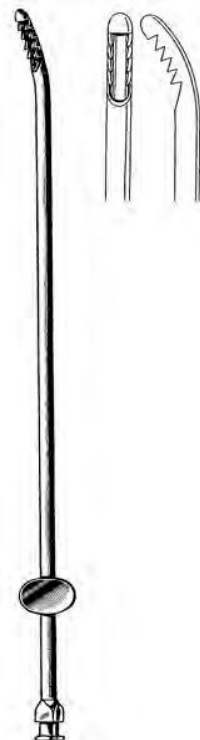

**K-27-795  
K-27-796  
K-27-797**

## CÁNULA PARA BIOPSIA

- K-27-794** Cánula Uterina de RANDALL, para Biopsia, 4 mm diam., 9¾" (24.8 cm)
- K-27-795** Cánula Uterina de NOVAK, para Biopsia, 2 mm diam., 9¾" (24.8 cm)
- K-27-796** Cánula Uterina de NOVAK, para Biopsia, 3 mm diam., 9¾" (24.8 cm)
- K-27-797** Cánula Uterina de NOVAK, para Biopsia, 4 mm diam., 9¾" (24.8 cm)"





**MASTERMED**  
MASTERS EN PRODUCTOS MÉDICOS

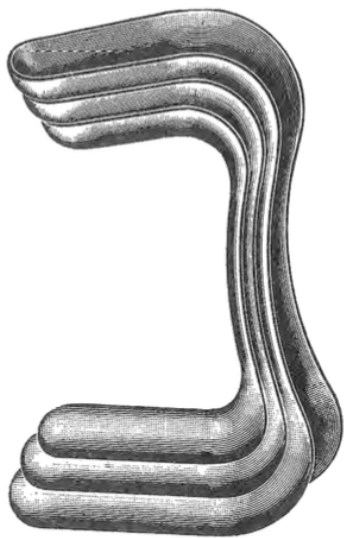
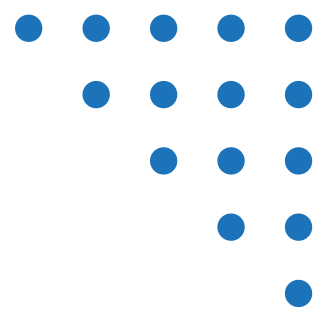

**K-27-700**  
to  
**K-27-706**

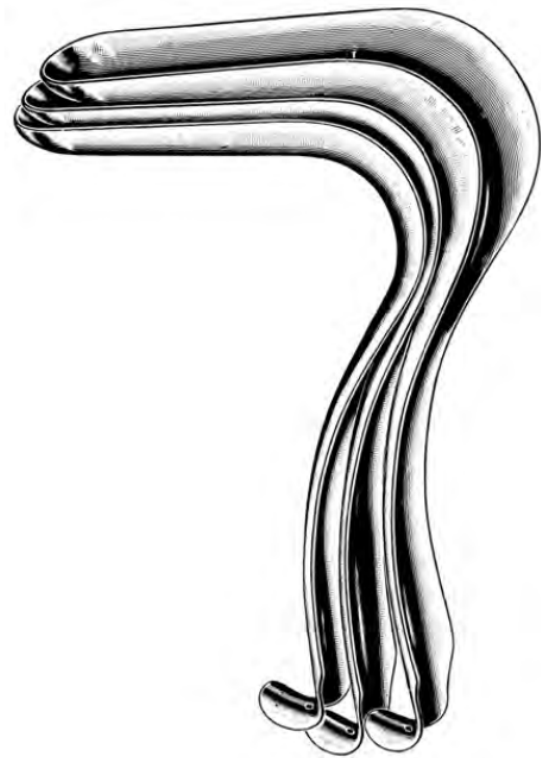

**K-27-707**  
To  
**K-27-711**

## INSTRUMENTAL PARA GINECOLOGÍA

- K-27-700**    Espéculo Vaginal SIMS, Doble Punta, Set of 3
- K-27-702**    Espéculo Vaginal SIMS, Pequeño, Doble punta, 1" (2.5 cm) x 2½" (6.4 cm) y 1¼" (3.2 cm) x 3" (7.6 cm)
- K-27-705**    Espéculo Vaginal SIMS, Mediano, Doble punta, 1⅞" (2.8 cm) x 3" (7.6 cm) y 1¼" (3.2 cm) x 3½" (8.9 cm)
- K-27-706**    Espéculo Vaginal SIMS, Grande, Doble punta, 1⅞" (3.5 cm) x 3½" (8.9 cm) y 1½" (3.8 cm) x 4" (10.2 cm)
  
- K-27-707**    Espéculo Vaginal KRISTELLER, Complete Set of 3
- K-27-709**    Espéculo Vaginal KRISTELLER, Pequeño (2.7 x 11 cm), 8½" (21.6 cm)
- K-27-710**    Espéculo Vaginal KRISTELLER, Mediano (3 x 11 cm), 8¾" (22.2 cm)
- K-27-711**    Espéculo Vaginal KRISTELLER, Grande (3.6 x 11 cm), 9" (22.9 cm)





**MASTERMED**  
MASTERS EN PRODUCTOS MÉDICOS

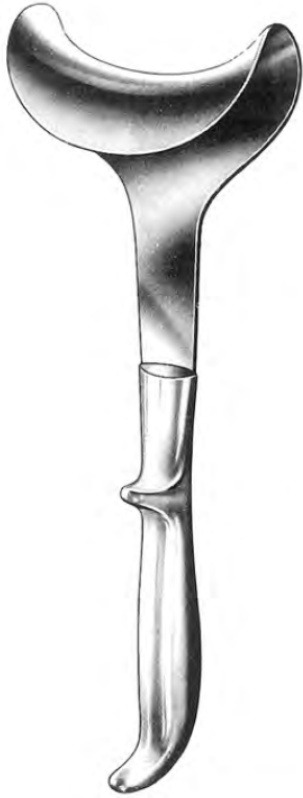
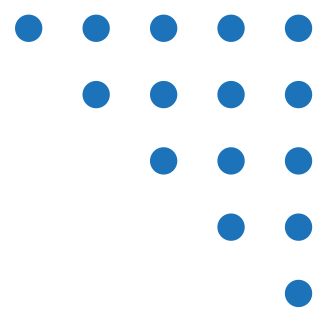

**K-26-713**



**K-26-732**

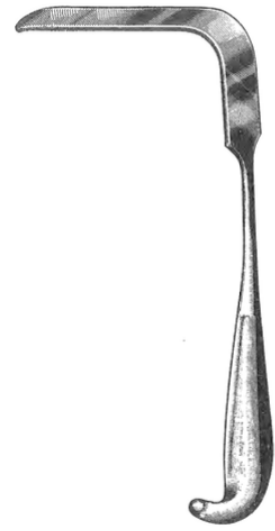

**K-27-712**

## INSTRUMENTAL PARA GINECOLOGÍA

- K-26-713** Separador Abdominal DOYEN, 8.5 ancho x 5 cm largo, 10" (25.4cm)
- K-26-732** Separador Vaginal Lateral, 2½" x 1" (6.4 x 2.5 cm), Mangos Dorados, 10½" (26.7cm)
- K-27-712** Separador Vaginal Heaney-Simon, Blade tamaño 1" x 4½" (2.5 x 11.4 cm), 11½"(29.2cm)





**MASTERMED**  
MASTERS EN PRODUCTOS MÉDICOS

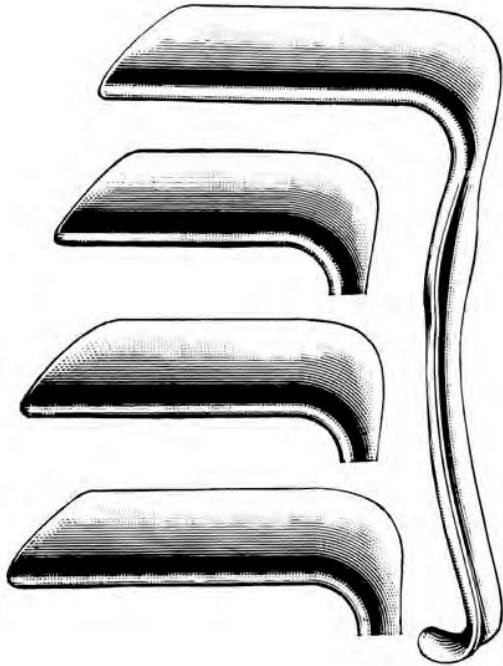
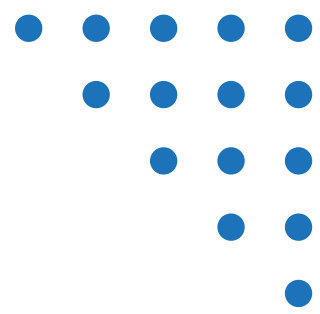

**K-27-867**  
**K-27-868**  
**K-27-869**



**K-27-880**  
**K-27-882**  
**K-27-884**

## INSTRUMENTAL PARA GINECOLOGÍA

- |                 |                                                                           |
|-----------------|---------------------------------------------------------------------------|
| <b>K-27-867</b> | Retractor Vaginal JACKSON, Pequeño, 1½ x 3" (3.8 x 7.6 cm), 7" (17.8 cm)  |
| <b>K-27-868</b> | Retractor Vaginal JACKSON, Mediano, 1½ x 3½" (3.8 x 8.9 cm), 7" (17.8 cm) |
| <b>K-27-869</b> | Retractor Vaginal JACKSON, Grande, 1½" x 4" (3.8 x 10.2 cm), 7" (17.8 cm) |
| <b>K-27-880</b> | Retractor Vaginal EASTMAN, Hoja 1½" x 3" (3.8 cm x 7.6 cm), 7" (17.8 cm)  |
| <b>K-27-882</b> | Retractor Vaginal EASTMAN, Hoja 1½" x 3½" (3.8 cm x 8.9 cm), 7" (17.8 cm) |
| <b>K-27-884</b> | Retractor Vaginal EASTMAN, Hoja 1½" x 4" (3.8 cm x 10.2 cm), 7" (17.8 cm) |





**MASTERMED**  
MASTERS EN PRODUCTOS MÉDICOS

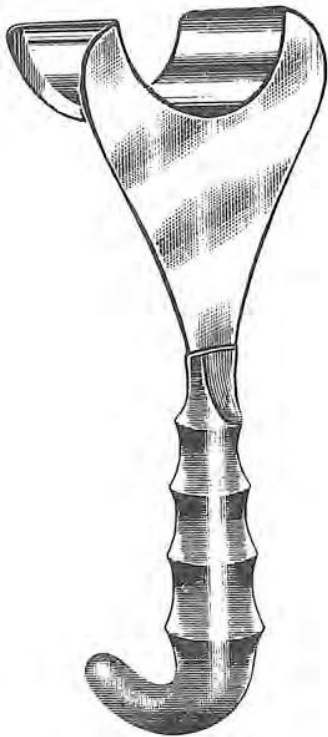

**K-27-888**

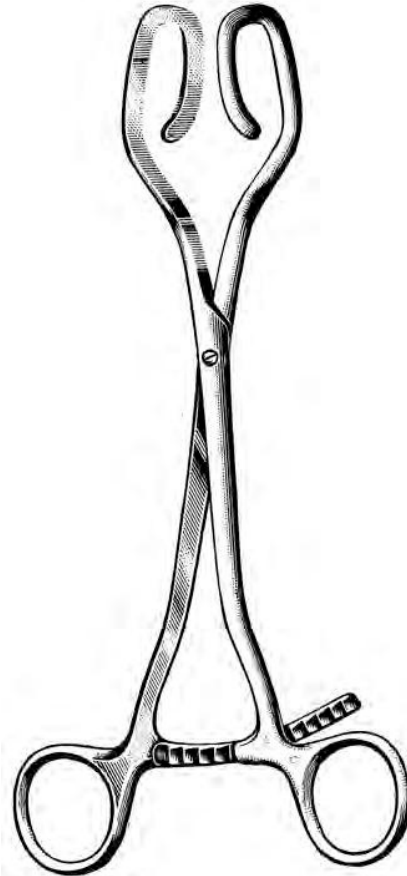

**K-27-785-E**



**K-27-785-F**

## INSTRUMENTAL PARA GINECOLOGÍA

**K-27-888** Retractor Universal de DeLEE, Hoja 3¾" x 2" (9.5 x 5.1 cm), 9½" (24.1 cm)

**K-27-785-E** Pinza Uterina DÁRTIGUES, Quijada lisa, Recta 10¾" (27.9 cm)

**K-27-785-F** Pinza Uterina SOMER, Punta curvada, Serrada (22.9 cm)





**MASTERMED**  
MASTERS EN PRODUCTOS MÉDICOS

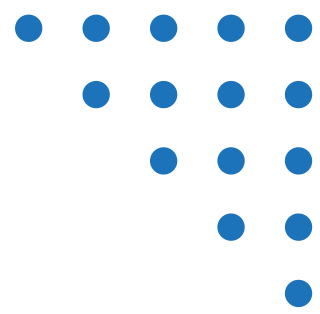

## CURETAS PARA GINECOLOGIA Y DILATADORES HEGAR

**K-27-800** Juego de Dilatadores HEGAR, Uterinos doble punta, 8 piezas con Estuche, Acero Inoxidable, tamaños de  $\frac{3}{4}$  mm a 17/18 mm, 7½" (19.1cm)





**MASTERMED**  
MASTERS EN PRODUCTOS MÉDICOS

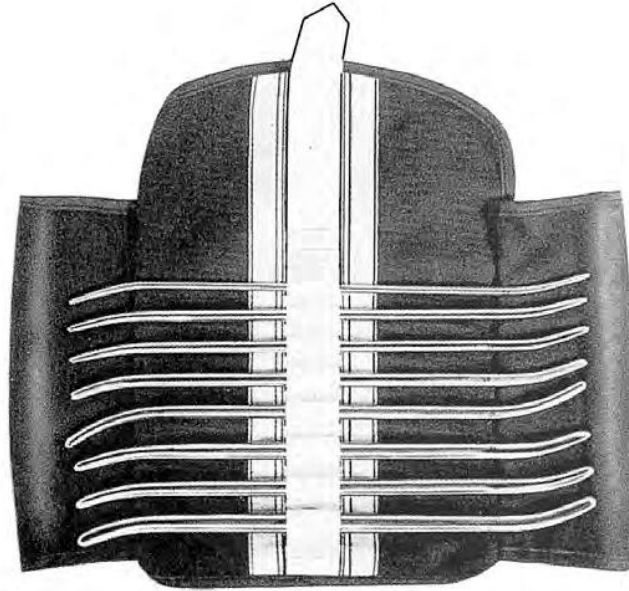
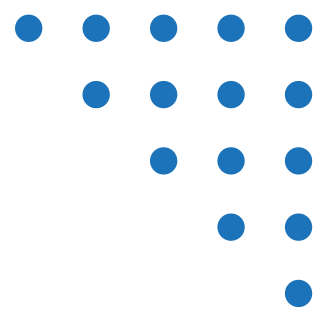

## CURETAS PARA GINECOLOGÍA Y DILATADORES PRATT

K-27-810 Juego de Dilatadores PRATT, Uterinos doble punta, 8 piezas con Estuche, en rollo Crema, tamaño 13/15 Fr. To 41/43 Fr., 11½" (29.2 cm)





MASTERMED  
MASTERS EN PRODUCTOS MÉDICOS

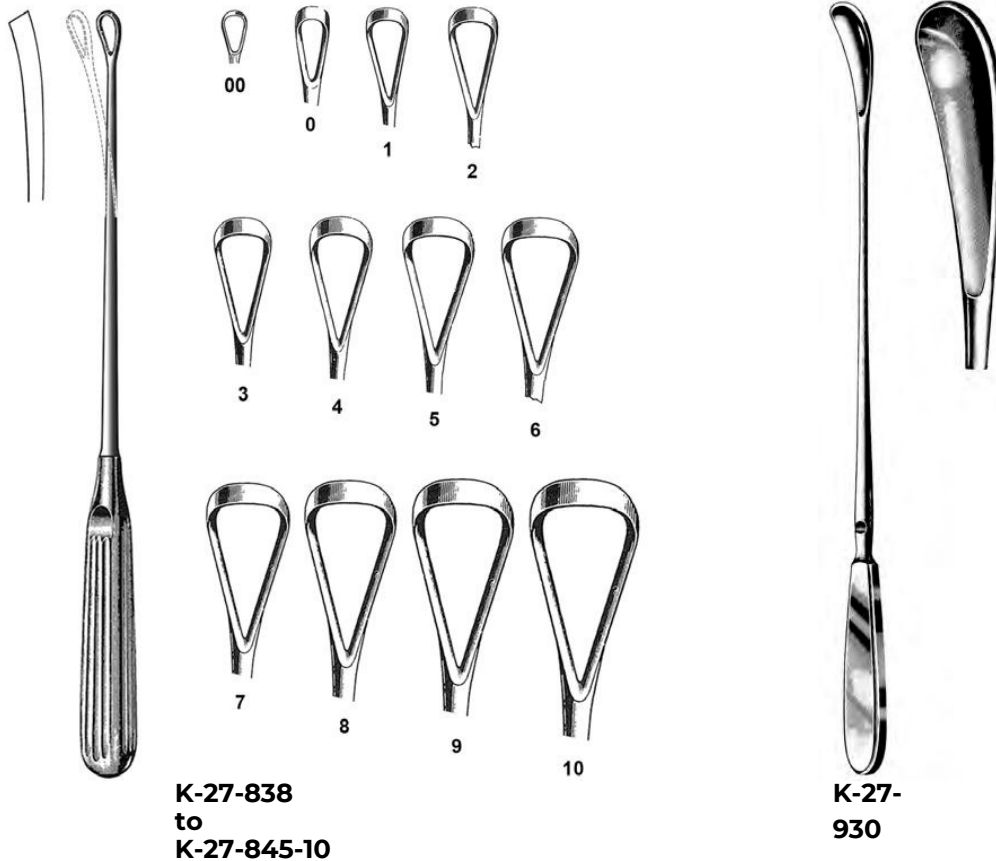

## CURETAS PARA GINECOLOGÍA Y DILATADORES

- 27-838** Cureta Uterina de SIMS, #00, con hoja afilada y vástago maleable, 11" (27.9 cm)
- 27-839** Cureta Uterina de SIMS, #0, con hoja afilada y vástago maleable, 11" (27.9 cm)
- 27-840** Cureta Uterina de SIMS, #1, con hoja afilada y vástago maleable, 11" (27.9 cm)
- 27-841** Cureta Uterina de SIMS, #2, con hoja afilada y vástago maleable, 11" (27.9 cm)
- 27-842** Cureta Uterina de SIMS, #3, con hoja afilada y vástago maleable, 11" (27.9 cm)
- 27-843** Cureta Uterina de SIMS, #4, con hoja afilada y vástago maleable, 11" (27.9 cm)
- 27-844** Cureta Uterina de SIMS, #5, con hoja afilada y vástago maleable, 11" (27.9 cm)
- 27-845** Cureta Uterina de SIMS, #6, con hoja afilada y vástago maleable, 11" (27.9 cm)
- 27-845-7** Cureta Uterina de SIMS, #7, con hoja afilada y vástago maleable, 11" (27.9 cm)
- 27-845-8** Cureta Uterina de SIMS, #8, con hoja afilada y vástago maleable, 11" (27.9 cm)
- 27-845-9** Cureta Uterina de SIMS, #9, con hoja afilada y vástago maleable, 11" (27.9 cm)
- 27-845-10** Cureta Uterina de SIMS, #10, con hoja afilada y vástago maleable, 11" (27.9 cm)

**K-27-930** Cureta WALLICH para aborto o retirada de Placenta, (1.9 cm) wide, 16¾" (41.9 cm)



MASTERMED  
MASTERS EN PRODUCTOS MÉDICOS

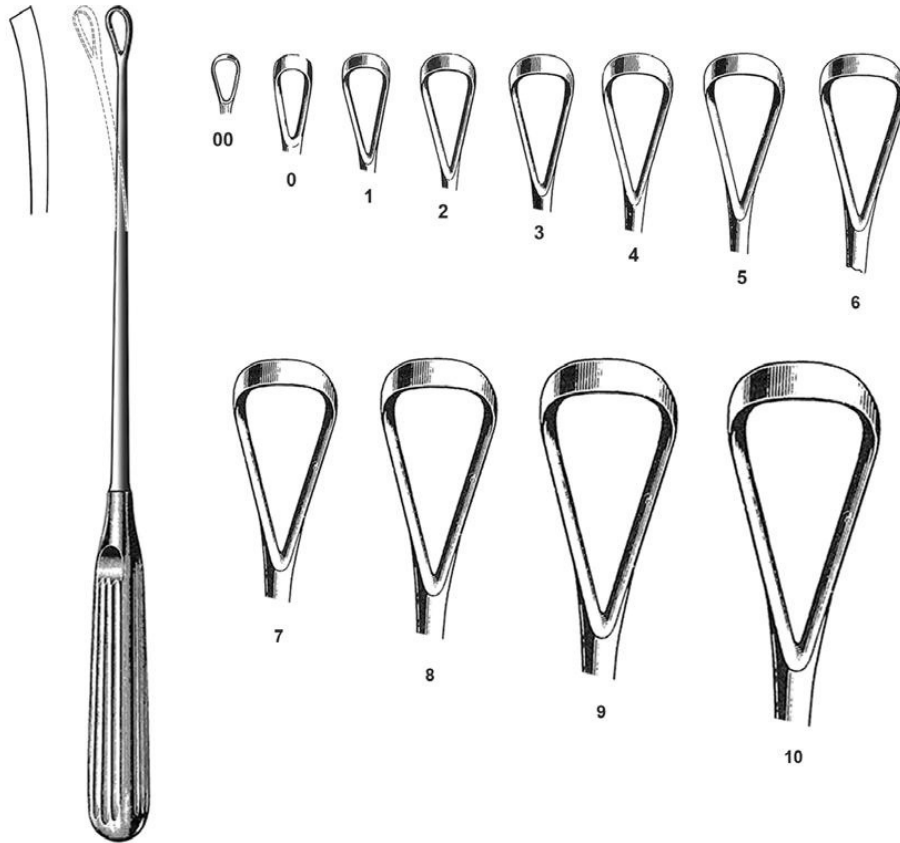

## CURETAS PARA GINECOLOGIA Y DILATADORES RECAMIER

- 27-838-00** Cureta Uterina de RECAMIER, con hoja afilada y vástago maleable tamaño 00, 12" (30.5 cm)
- 27-839-0** Cureta Uterina de RECAMIER, con hoja afilada y vástago maleable tamaño 0, 12" (30.5 cm)
- 27-840-1** Cureta Uterina de RECAMIER, con hoja afilada y vástago maleable tamaño 1, 12" (30.5 cm)
- 27-841-2** Cureta Uterina de RECAMIER, con hoja afilada y vástago maleable tamaño 2, 12" (30.5 cm)
- 27-842-3** Cureta Uterina de RECAMIER, con hoja afilada y vástago maleable tamaño 3, 12" (30.5 cm)
- 27-843-4** Cureta Uterina de RECAMIER, con hoja afilada y vástago maleable tamaño 4, 12" (30.5 cm)
- 27-844-5** Cureta Uterina de RECAMIER, con hoja afilada y vástago maleable tamaño 5, 12" (30.5 cm)
- 27-845-6** Cureta Uterina de RECAMIER, con hoja afilada y vástago maleable tamaño 6, 12" (30.5 cm)
- 27-846-7** Cureta Uterina de RECAMIER, con hoja afilada y vástago maleable tamaño 7, 12" (30.5 cm)
- 27-847-8** Cureta Uterina de RECAMIER, con hoja afilada y vástago maleable tamaño 8, 12" (30.5 cm)
- 27-849-9** Cureta Uterina de RECAMIER, con hoja afilada y vástago maleable tamaño 9, 12" (30.5 cm)
- 27-849-10** Cureta Uterina de RECAMIER, con hoja afilada y vástago maleable tamaño 10, 12", (30.5 cm)



MASTERMED  
MASTERS EN PRODUCTOS MÉDICOS

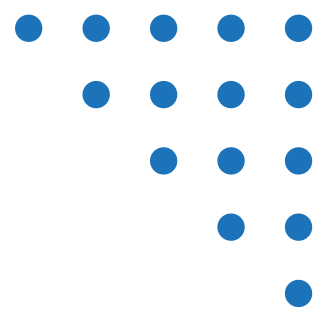

**K-27-855**

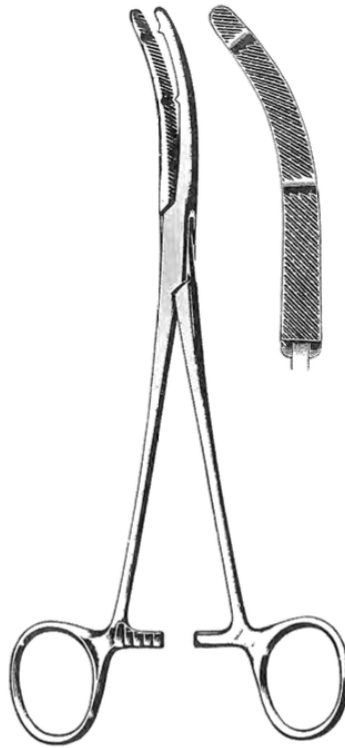

**K-27-856**  
**K-27-857**

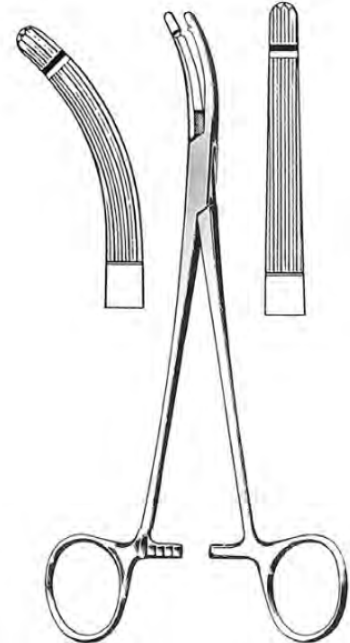

**K-27-857-A**  
**K-27-857-B**

## PINZAS PARA HISTERECTOMÍA

- K-27-855** Pinza HEANEY para Histerectomía, 1 Diente, Curva, 8¼" (21 cm)
- K-27-856** Pinza HEANEY para Histerectomía, 2 Dientes, Curva, 8¼" (21 cm)
- K-27-857** Pinza HEANEY para Histerectomía, 2 Dientes Gruesos, Curva, 9¾" (24.8 cm)
- K-27-857-A** Pinza HEANEY-BALLENTINE para Histerectomía, Longitudinal, Serrada, Curva con diente, 8½" (21.6 cm)
- K-27-857-B** Pinza HEANEY BALLENTINE para Histerectomía, Longitudinal, Serrada, Recta con diente, 8½" (21.6 cm)







**MASTERMED**  
MASTERS EN PRODUCTOS MÉDICOS

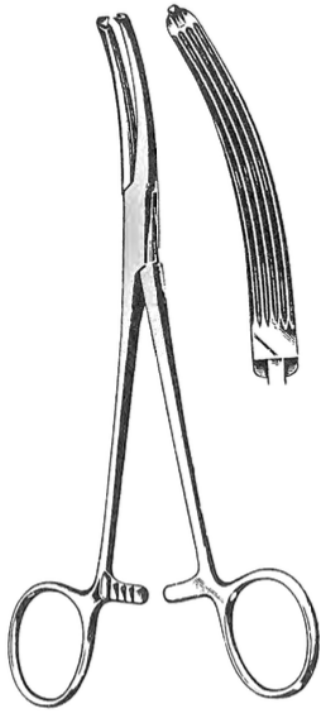
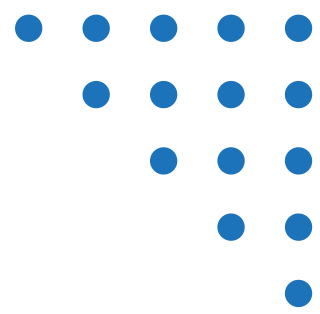

**K-27-858**



**K-27-858-A**

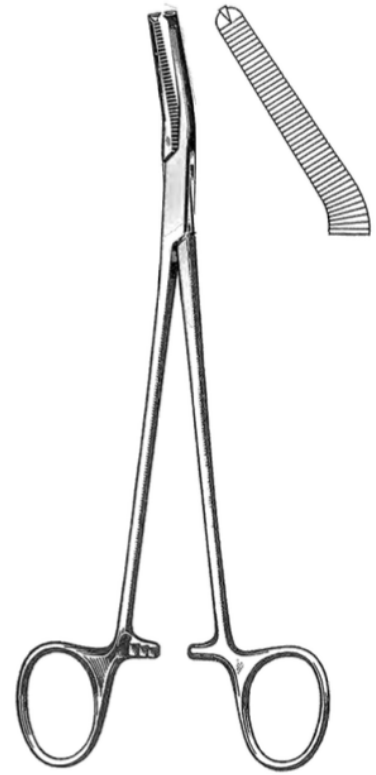

**K-27-858-B**

## PINZAS PARA HISTERECTOMÍA

**K-27-858** Pinza LONG para Histerectomía, Longitudinal, serrada, Curva, Dientes 1 x 2, 7½" (19.1 cm)

**K-27-858-A** Pinza Uterina PHANUEF, Dientes 1 x 2, Recta, 8¼" (21 cm)

**K-27-858-B** Pinza Uterina PHANUEF, Dientes 1 x 2, Agulada, 8½" (21.6 cm)





MASTERMED  
MASTERS EN PRODUCTOS MÉDICOS

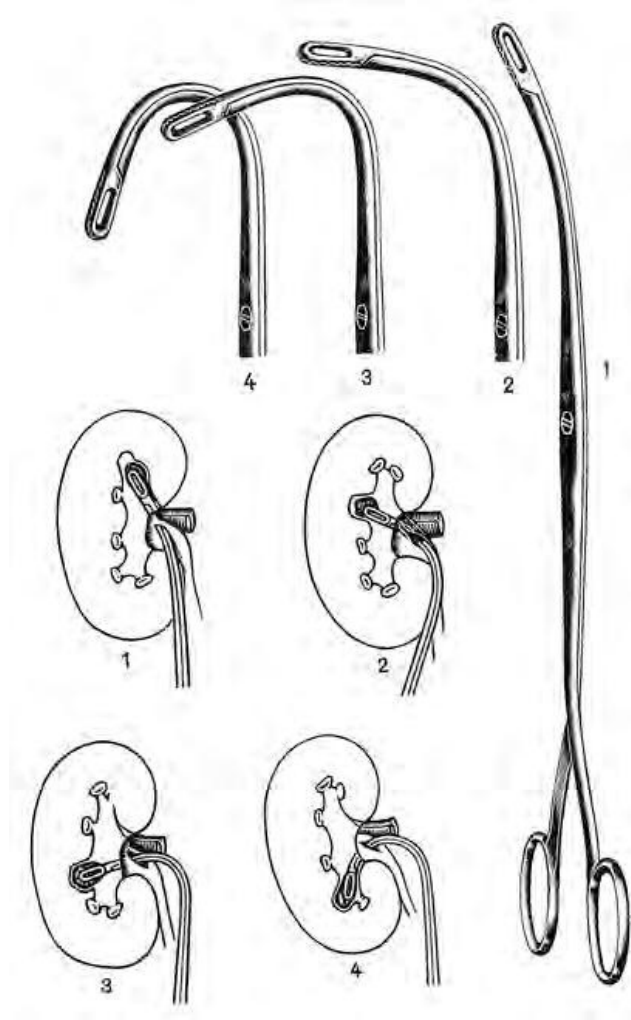

## PINZAS PARA CALCULOS BILIARES

- K-28-850** Pinza RANDALL, Un cuarto de Curva, No.1, 9½" (24.1 cm)
- K-28-851** Pinza RANDALL, Media Curva, No.2, 8¼" (21 cm)
- K-28-852** Pinza RANDALL, Tres cuartos de Curva, No.3, 7¾" (19.7 cm)
- K-28-853** Pinza RANDALL, Curva Completa, No.4, 7½" (19.1 cm)



**MASTERMED**  
MASTERS EN PRODUCTOS MÉDICOS

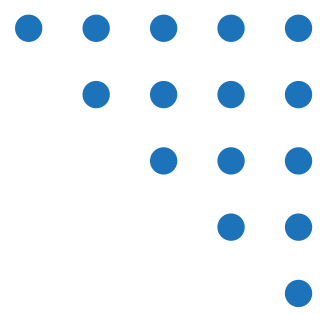

**K-28-820**

**K-28-821**  
**K-28-822**

**K-28-824**  
**K-28-825**

**K-28-827**

**K-28-829**

## PINZAS OBSTÉTRICAS

- K-28-820** Pinza Obstetrica DeLEE, Corto, 12" (30.5 cm)
- K-28-821** Pinza Obstetrica DeLEE, Estandar, 14" (35.6 cm)
- K-28-822** Pinza Obstetrica DeLEE, Largo, 15¼" (38.7 cm)
- K-28-824** Pinza Obstetrica de ELLIOT, Corto, 12½" (31.8 cm)
- K-28-825** Pinza Obstetrica de ELLIOT, Largo, 14" (35.6 cm)
- K-28-827** Pinza Obstetrica de SIMPSON, Corto, 12" (30.5 cm)
- K-28-829** Pinza Obstetrica de SIMPSON, Largo, 14" (35.6 cm)





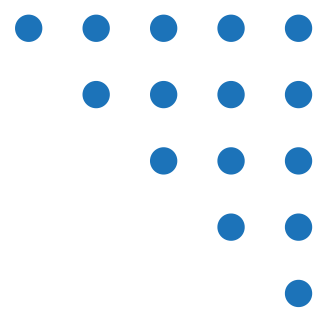

**K-28-830**



**K-28-831**

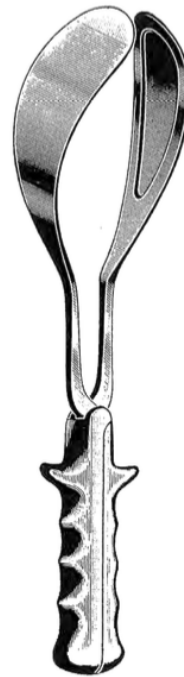

**K-28-833**



**K-28-835**

## PINZAS OBSTÉTRICAS

- K-28-830** Pinza Obstetrica de KIELAND, 5½" (39.4 cm)
- K-28-831** Pinza Obstetrica de KIELAND-LUIKART, solid blades, 15½" (39.4 cm)
- K-28-833** Pinza Obstetrica de SIMPSON-LUIKART, solid blades, 14" (35.6 cm)
- K-28-835** Pinza Obstetrica de LUIKART, solid blades, 15½" (39.4 cm)





MASTERMED  
MASTERS EN PRODUCTOS MÉDICOS

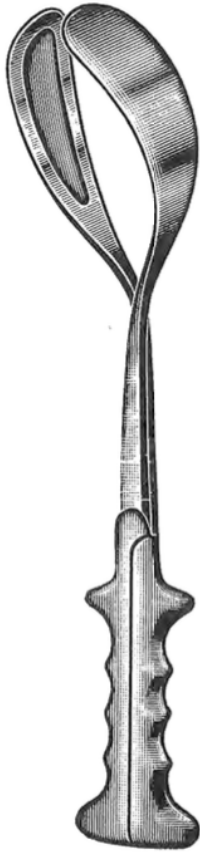
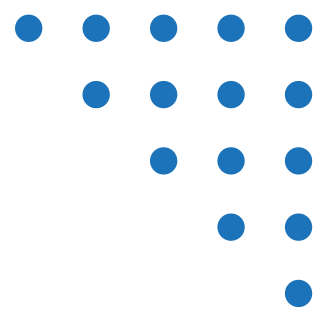

**K-28-837**



**K-28-839**



**K-28-843**

## PINZAS OBSTÉTRICAS

- K-28-837** Pinza Obstetrica de MCLEAN-LUIKART, Hoja solida, mango largo, 15 $\frac{3}{4}$ " (40 cm)
- K-28-839** Pinza Obstetrica de PIPER, 17 $\frac{1}{2}$ " (44.5.cm)
- K-28-843** Pinza KELLY para Placenta, Aros estriados, 12 $\frac{1}{2}$ " (31.8 cm)





**MASTERMED**  
MASTERS EN PRODUCTOS MÉDICOS

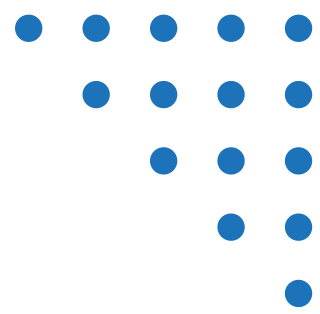

**K-28-860-V**



**K-28-863-V**

## INSTRUMENTAL PARA VASECTOMÍA SIN BISTURÍ

- K-28-860-V** Pinza para fijación del conducto deferente, para uso extra cutáneo y la terminación de las puntas forman un anillo de 3.5 mm de diámetro, Longitud de (14 cm), Mangos Dorados
- K-28-863-V** Pinza de disección tipo Hemostática sin estrías curva, con quijadas planas y punta muy fina (agudizada), Longitud de (14 cm), Mangos Dorados





**MASTERMED**  
MASTERS EN PRODUCTOS MÉDICOS

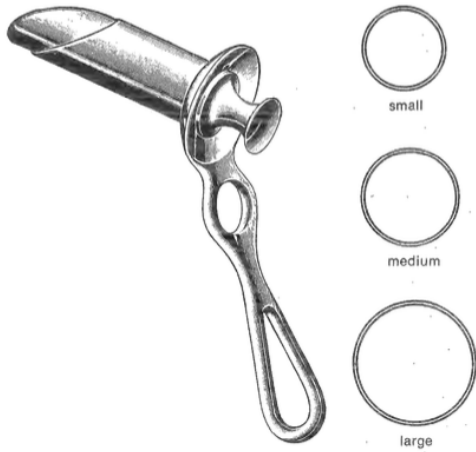

**K-29-860**  
**K-29-861**  
**K-29-862**

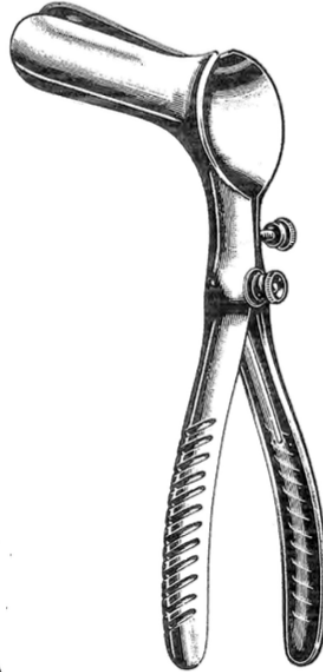

**K-29-863**



**K-29-864**



**K-29-865**

## INSTRUMENTAL RECTAL

- K-29-860** Anoscopio HIRSCHMAN, Pequeño, 2½" x 9/16"  
**K-29-861** Anoscopio HIRSCHMAN, Mediano, 2¾" x 11/16"  
**K-29-862** Anoscopio HIRSCHMAN, Grande, 3½" x 7/8"
- K-29-863** Espéculo PRATT, Rectal 8½" (21.6 cm)  
**K-29-864** Espéculo SIMS, Rectal 6" (15.2 cm)  
**K-29-865** Espéculo BODENHAMMER, Rectal, 3½" x 5/8", 6" (15.2 cm)



MASTERMED  
MASTERS EN PRODUCTOS MÉDICOS

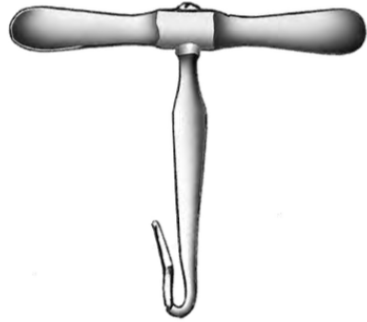

**K-30-904**

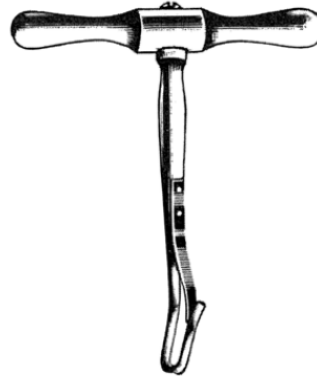

**K-30-904-A**

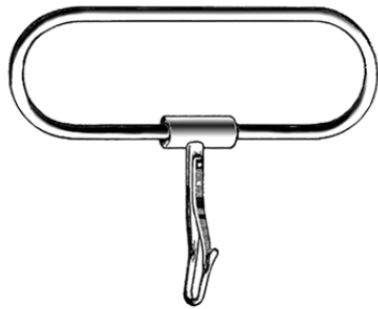

**K-30-905**



**706-101  
706-119  
706-127**

## SIERRAS PARA HUESO Y MANGO CON SIERRAS

- K-30-904** Mango para Sierra de Alambre de GIGLI-STRULLY, en forma de "T" giratorio, Juego 2 pzas, 2" (5.1 cm)
- K-30-904-A** Mango para Sierra de Alambre de GIGLI-STRULLY, en forma de "T" giratorio, con seguro de presión, Juego 2 pzas (5 cm)
- K-30-905** Mango para Sierra de Alambre de GIGLI-STRULLY, rígido, con seguro de presión, Juego 2 pzas, 3½" (8.9 cm)
- 706-101** Sierra de GIGLI, tipo estandar con alambre enroscado (30.5 cm)  
**706-119** Sierra de GIGLI, tipo estandar con alambre enroscado (50.8 cm)  
**706-127** Sierra de GIGLI, tipo estandar con alambre enroscado (76.2 cm)



**MASTERMED**  
MASTERS EN PRODUCTOS MÉDICOS

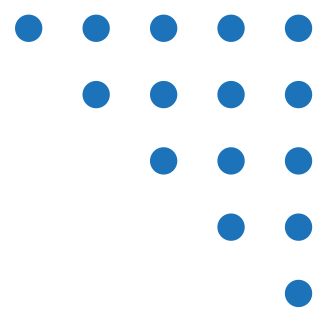

**33-1020**  
**33-1022**



**33-1029**



**33-1030**



**33-1031**

## SIERRAS PARA HUESO Y MANGO CON SIERRAS

- 33-1020** Sierra de Hueso CHARRIERE, Hoja de 7" (17.8 cm), Mango de cromo  
**33-1022** Sierra de Hueso CHARRIERE, Hoja de 9½" (24.1 cm), Mango de cromo
- 33-1029** Sierra de Hueso SATERLEE, Hoja de 9½" (24.1 cm), Mango de cromo, 12" (30.5 cm)
- 33-1030** Sierra de Hueso, Punta circular, Hoja de 8" (20.3 cm), Mango de cromo, 12" (30.5 cm)
- 33-1031** Sierra Metacarpiano de BRUNS (LANGENBECK), Hoja de 4½" (11.4 cm), 9½" (24.1 cm)





**MASTERMED**  
MASTERS EN PRODUCTOS MÉDICOS

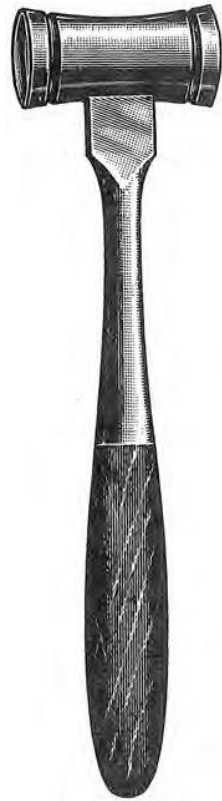
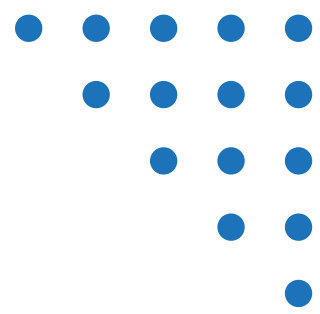

**33-1034**



**33-1035**  
**33-1036**

## MAZOS

- 33-1034** Mazo Ortopedico relleno de plomo, 18 oz., 70 mm x 35 mm, cara 1 $\frac{1}{3}$ " de diam., #704-966 Crown, 9 $\frac{3}{4}$ " (24.8 cm)
- 33-1035** Mazo Fino de Acero Inoxidable., Cabeza 16 oz. (456g), #704-958 Crown, 11" (27.9 cm)
- 33-1036** Mazo Fino de Acero Inoxidable., Cabeza 32 oz. (908g), #704-959 Crown, 11" (27.9 cm)





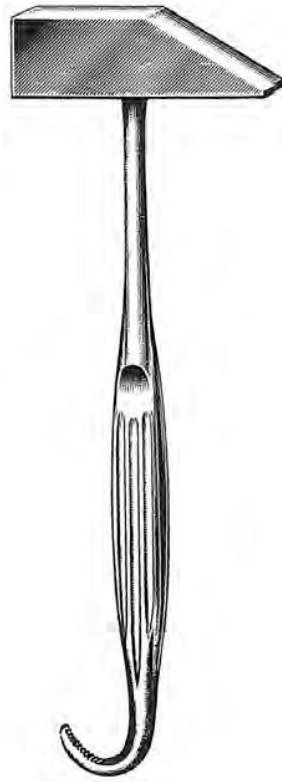
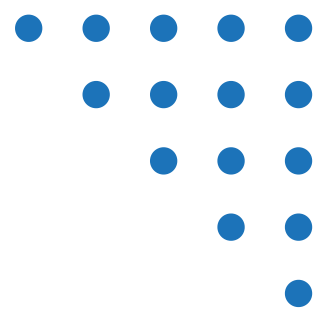

**K-33-1032**



**K-33-1033**

## INSTRUMENTOS POST MORTORIOS Y ORTOPÉDICOS

**K-33-1032** Martillos Post Mortorios con mango de enganche, 12 oz.,  
Cabeza 20 x 2 x 75 mm, 9½" (24.1 cm)

**K-33-1033** Martillos de Acero, 12 oz., cara 1⅞" de diametro, 9" (22.9 cm)







**MASTERMED**  
MASTERS EN PRODUCTOS MÉDICOS

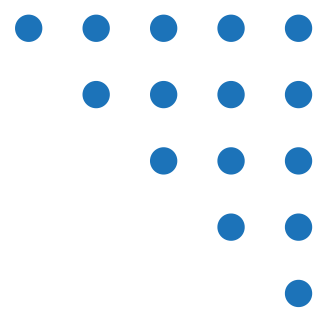

**061-798**

**061-800**

**061-805**

**061-810**

**061-815**

## MANGO PARA LARINGOSCOPIO ESTANDAR (SIN BATERIAS)

- 061-798** Mango para Laringoscopio, Pequeño, (Batería "AA") ( Mac y Miller)
- 061-800** Mango para Laringoscopio, Mediano, (Batería "C") ( Mac y Miller)
- 061-805** Mango para Laringoscopio, Grande, (Batería "D") (Mac y Miller)
- 061-810** Bombillas 2.5 Voltios, Pequeña (Tamaño 1 y 2 ; 0 y 1) (Mac y Miller)
- 061-815** Bombillas 2.5 Voltios, Grandes (Tamaño 3 y 4 ; 2, 3 y 4 ) (Mac y Miller)





**MASTERMED**  
MASTERS EN PRODUCTOS MÉDICOS

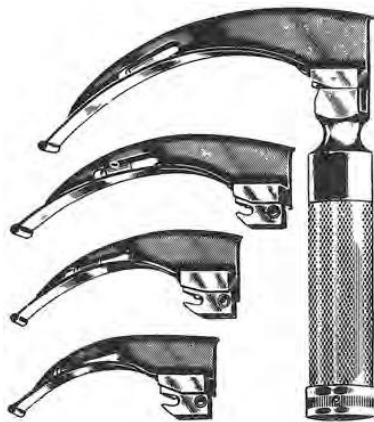

### ESTUCHE DE LARINGOSCOPIO MACINTOSH ( SIN BATERIAS ) CON MANGO MEDIANO "C" Y CON UNA BOMBILLA EXTRA Y CON SU ESTUCHE

- 061-807** Estuche de MACINTOSH, Pediátrico, incluye 5 hojas Tamaños, 00, 0, 1, 2 y 3
- 061-808** Estuche de MACINTOSH, Pediátrico con 4 hojas No. 00, 0, 1, 2,
- 061-809** Estuche de MACINTOSH, con 4 hojas No. 0, 1, 2, 3
- 061-811** Estuche de MACINTOSH, con 4 hojas No. 1, 2, 3, 4
- 061-813** Estuche de MACINTOSH, Laringoscopio Set, con 5 Hojas, No. 0,1, 2, 3 y 4,



**MASTERMED**  
MASTERS EN PRODUCTOS MÉDICOS



**061-812 to  
061-817**

**061-818  
061-818-A**

### **ESTUCHE DE LARINGOSCOPIO MILLER (SIN BATERIAS ) CON MANGO MEDIANO "C" Y CON UNA BOMBILLA EXTRA Y CON SU ESTUCHE**

- 061-812** Estuche de MILLER, Pediátrico, incluye 5 hojas Tamáños, 00, 0, 1, 2 y 3
- 061-814-A** Estuche de MILLER, Pediátrico con 4 hojas No.00, 0, 1, 2
- 061-814-B** Estuche de MILLER, Pediátrico con 4 hojas No. 0,1,2,3
- 061-816** Estuche de MILLER, con 4 hojas No. 1,2,3 y 4
- 061-817** Estuche de MILLER, con 5 hojas No. 0,1,2,3 y 4
- 061-818** Estuche Combinado con 8 Hojas MILLER (1,2,3, y 4) MACINTOSH (1,2,3 y 4) con dos bombillas
- 061-818-A** Estuche Combinado con 10 Hojas MILLER (0,1,2,3 y 4) MACINTOSH (0,1,2,3 y 4) con dos bombillas



**MASTERMED**  
MASTERS EN PRODUCTOS MÉDICOS

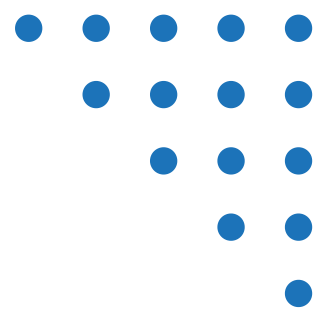

**Enganche Adjunto**



**061-819**



**061-820**



**061-825**

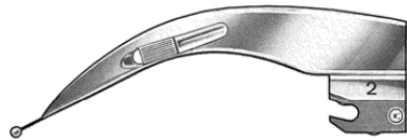

**061-830**



**061-835**



**061-840**



**061-841**

## HOJAS PARA LARINGOSCOPIOS-ESTANDAR MACINTOSH

**061-819** Tamaño 00, Pequeño  
**061-820** Tamaño 0, Prematuro  
**061-825** Tamaño 1, Infantil  
**061-830** Tamaño 2, Niño

**061-835** Tamaño 3, Adulto Mediano  
**061-840** Tamaño 4, Adulto Grande  
**061-841** Tamaño 5, Adulto Extra Grande





**MASTERMED**  
MASTERS EN PRODUCTOS MÉDICOS

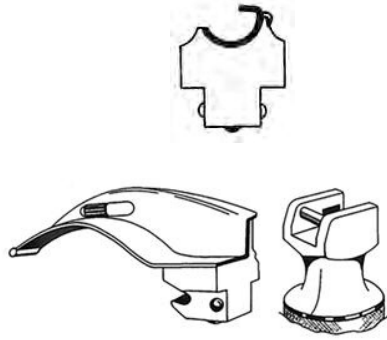
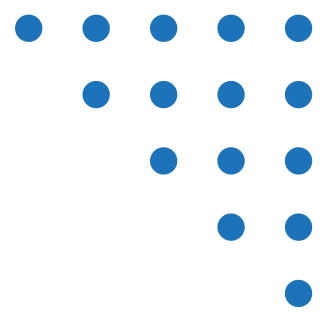

**Enganche Adjunto**



**061-844**



**061-845**



**061-850**



**061-855**

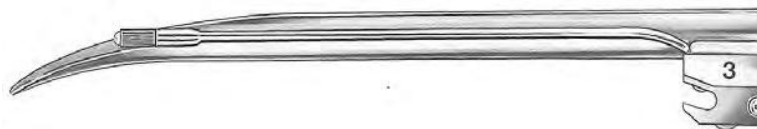

**061-860**

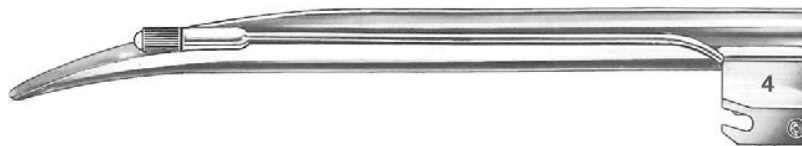

**061-865**

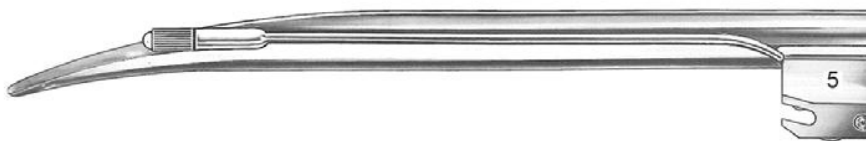

**061-866**

## HOJAS PARA LARINGOSCOPIOS-ESTANDAR MILLER

- 061-844** Hojas para Laringoscopios MILLER, Tamaño
- 061-845** Hojas para Laringoscopios MILLER, Tamaño
- 061-850** Hojas para Laringoscopios MILLER, Tamaño
- 061-855** Hojas para Laringoscopios MILLER, Tamaño
- 061-860** Hojas para Laringoscopios MILLER, Tamaño
- 061-865** Hojas para Laringoscopios MILLER, Tamaño
- 061-866** Hojas para Laringoscopios MILLER, Tamaño

- 00, Pequeño Prematuro ,
- 0Prematuro
- 1, Infantil
- 2, Niño
- 3, Adulto Mediano
- 4, Adulto Grande
- 5, Adulto Extra Grande



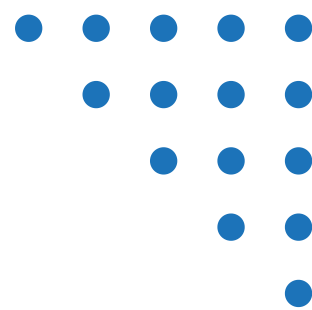

**MACINTOSH**



**MILLER**



**LED**

## **MANGO LARINGOSCOPIO FIBRA OPTICA (SIN BATERIAS)**

**061-798-F/O** Mango de Fibra Optica para Laringoscopio, Pequeño, (Batería "AA") (Mac y Miller)

**061-800-F/O** Mango de Fibra Optica para Laringoscopio, Mediano, (Batería "C") (Mac y Miller)

**061-805-F/O** Mango de Fibra Optica para Laringoscopio, Grande, (Batería "D") (Mac y Miller)

**061-810-F/O** Bombilla de Halogeno, 2.5 Voltios, Fibra Optica para tamaños Pequeño, Mediano y Grande







**MASTERMED**  
MASTERS EN PRODUCTOS MÉDICOS



**061-807-FO**



**061-812-FO  
to  
061-817-F/O**



**061-808-FO**

## ESTUCHES DE MACINTOSH Y MILLER FIBRA OPTICA (SIN BATERIAS) CON MANGO MEDIANO "C" Y CON UNA BOMBILLA EXTRA Y CON SU ESTUCHE

- 061-807-F/O** Estuche de MACINTOSH, Fibra Optica, Pediátrico, incluye 5 hojas  
Tamaños, 00, 0, 1, 2 y 3
- 061-808-F/O** Estuche de MACINTOSH, Fibra Optica, Infante, incluye 4 hojas  
Tamaños, 00, 0, 1, y 2
- 061-809-F/O** Estuche de MACINTOSH, Fibra Optica, incluye 4 hojas No. 0, 1, 2, y 3
- 061-811 F/O** Estuche de MACINTOSH, Fibra Optica, incluye 4 hojas No. 1, 2, 3 y 4
- 061-813 F/O** Estuche de MACINTOSH, Fibra Optica, incluye 5 hojas No. 0,1, 2, 3 y 4
  
- 061-812-F/O** Estuche de MILLER, Fibra Optica, Pediátrico, incluye 5 hojas  
Tamaños 00, 0, 1, 2 y 3
- 061-814-F/O** Estuche de MILLER, Fibra Optica, Infante, incluye 4 hojas  
Tamaños, 00, 0, 1, y 2
- 061-815-F/O** Estuche de MILLER, Fibra Optica, incluye 4 hojas No. 0, 1, 2, y 3
- 061-816-F/O** Estuche de MILLER, Fibra Optica, incluye 4 hojas No. 1, 2, 3 y 4
- 061-817-F/O** Estuche de MILLER, Fibra Optica, incluye 5 hojas No. 0,1, 2, 3 y 4



**MASTERMED**  
MASTERS EN PRODUCTOS MÉDICOS

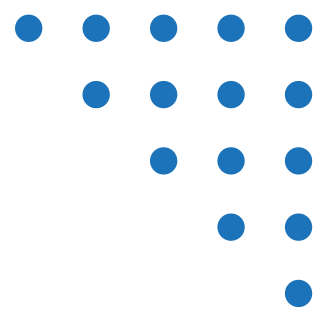

**061-818-FO**



**061-818-A-FO**

## ESTUCHES COMBINADO DE MACINTOSH Y MILLER FIBRA OPTICA (SIN BATERIAS) CON MANGO MEDIANO "C" Y CON UNA BOMBILLA EXTRA Y CON SU ESTUCHE

- 061-818-F/O** Estuche Combinado con 8 Hojas: MILLER (1,2, y 3) y MACINTOSH (1,2, y 3) con dos bombillas
- 061-818-A-F/O** Estuche Combinado con 10 Hojas MILLER (0,1,2,3 y 4) y MACINTOSH (0,1,2,3 y 4) con dos bombillas







**MASTERMED**  
MASTERS EN PRODUCTOS MÉDICOS

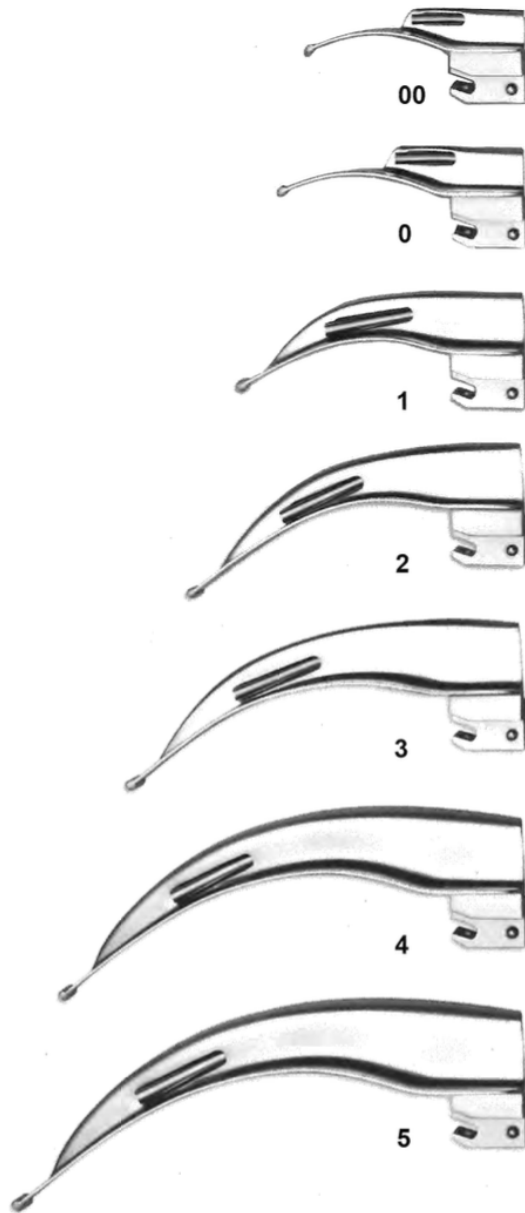

## HOJAS PARA LARINGOSCOPIOS-DE FIBRA OPTICA MACINTOSH

- 061-819-F/O** Hojas para Laringoscopio, MACINTOSH Fíbra Optica, Curva, No. 00, Pequeño, Prematuro
- 061-820-F/O** Hojas para Laringoscopio, MACINTOSH Fíbra Optica, Curva, No. 0, Prematuro
- 061-825-F/O** Hojas para Laringoscopio, MACINTOSH Fíbra Optica, Curva, No. 1, Infantil
- 061-830-F/O** Hojas para Laringoscopio, MACINTOSH Fíbra Optica, Curva, No. 2, Niño
- 061-835-F/O** Hojas para Laringoscopio, MACINTOSH Fíbra Optica, Curva, No. 3, Adulto Mediano
- 061-840-F/O** Hojas para Laringoscopio, MACINTOSH Fíbra Optica, Curva, No. 4, Adulto Grande
- 061-841-F/O** Hojas para Laringoscopio, MACINTOSH Fíbra Optica, Curva, No. 5, Adulto Extra Grande



**MASTERMED**  
MASTERS EN PRODUCTOS MÉDICOS



00



0



1



2



3



4

## HOJAS PARA LARINGOSCOPIOS-DE FIBRA ÓPTICA MILLER

**061-844-F/O** Hojas para Laringoscopio, MILLER Fíbra Optica, Curva, No. 00, Pequeño Prematuro

**061-845-F/O** Hojas para Laringoscopio, MILLER Fíbra Optica, Curva, No. 0, Prematuro

**061-850-F/O** Hojas para Laringoscopio, MILLER Fíbra Optica, Curva, No. 1, Infantil

**061-855-F/O** Hojas para Laringoscopio, MILLER Fíbra Optica, Curva, No. 2, Niño

**061-860-F/O** Hojas para Laringoscopio, MILLER Fíbra Optica, Curva, No. 3, Adulto Mediano

**061-865-F/O** Hojas para Laringoscopio, MILLER Fíbra Optica, Curva, No. 4, Adulto Grande

**061-866-F/O** Hojas para Laringoscopio, MILLER Fíbra Optica, Curva, No. 5, Adulto Extra Grande



**MASTERMED**  
MASTERS EN PRODUCTOS MÉDICOS

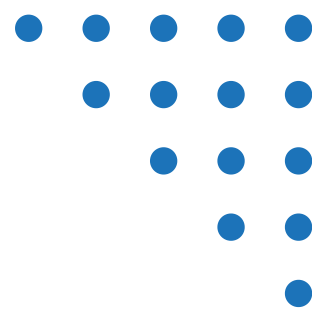

034-217  
034-218



034-219

### EQUIPO DE OTOSCOPIA, ECONÓMICO (SIN BATERÍAS)

- 034-217** Stetoscopio de PINARD para corazón fetal, Aluminio
- 034-218** Stetoscopio de PINARD para corazón fetal, Plástico, color negro, azul y verde
- 034-219** Stetoscopio Obstetrico DeLEE HILLIS, con soporte para la cabeza, Cromado





061-870

061-875

## EQUIPO DE OTOSCOPIA, ECONÓMICO (SIN BATERÍAS)

- 061-870** Otoscopio Económico con lentes móviles y 3 espéculas, Cromadas, esterilizable, mango con tornillo ajustable, dos bombillas de repuesto y estuche
- 061-875** Set de Diagnóstico (Oído, Nariz y Garganta)  
Set Incluye:
- Mango
  - Oftalmoscopio
  - Otoscopio
  - Tips re-usables: 2.5 mm, 3.5 mm y 4.5 mm
  - Espéculo Nasal con Tornillo
  - Depresor de Lengua
  - Depresor de Lengua con Luz
  - Espejo Laringeo #2
  - Espejo Laringeo #3
  - Depresor de Lengua para Hojas de Madera



**MASTERMED**  
MASTERS EN PRODUCTOS MDICOS

## CEPILLOS DE LIMPIEZA PARA CIRUJANO



### CEPILLOS DE LIMPIEZA PARA CIRUJANO CON CERDAS DE NYLON Y ACERO

- 965-690** Cerdas de Nylon, Paquete de 3
- 965-692** Cerdas de Nylon, Paquete de 12
- 965-694** Cerdas de Nylon, Paquete de 24
- 965-695** Cerdas de Acero, Paquete de 3
- 965-697** Cerdas de Acero, Paquete de 12
- 965-699** Cerdas de Acero, Paquetes de 24



### CEPILLO DE CANULA CON CERDAS

- 965-712** 2¼" x ¼" x 12" largo, 3 mm diam. Paq. de 3
- 965-713** 2¼" x ¼" x 12" largo, 4 mm diam. Paq. de 3
- 965-714** 2¼" x ¾" x 16" largo, 7 mm diam. Paq. de 3
- 965-715** 2¼" x ¾" x 16" largo, 10 mm diam. Paq. de 3
- 965-716** 3½" x 1" x 16" largo, 25 mm diam. Paq. de 3



### CEPILLO DE TUBO DE TRAQUEA

- 965-718** 2¼" x ¼" x 6" largo, Pequeño, 13 mm diam, Paq. of 3
- 965-720** 2¼" x ¾" x 7" largo, Mediano, 16 mm diam, Paq. of 3
- 965-722** 3½" x 1" x 7½" largo, Largo, 19 mm diam, Paq. of 3
- 965-724** Paquete de 3: Pequeño, Mediano, Largo

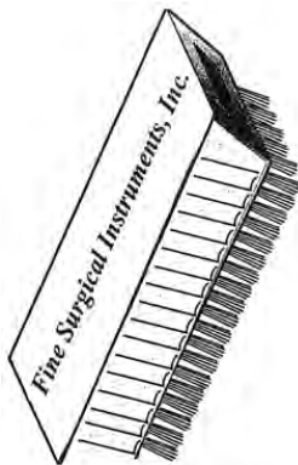

### CEPILLO SURGEONS

- 965-700** Estandar
- 965-702** Estandar, Paquete de 12

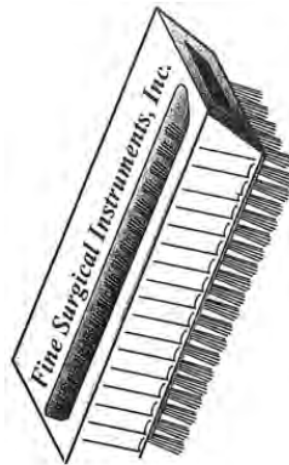

### CEPILLO SURGEONS

- 965-704** Con Tallador de uñas
- 965-706** Con Tallador de uñas, Paq. de 12

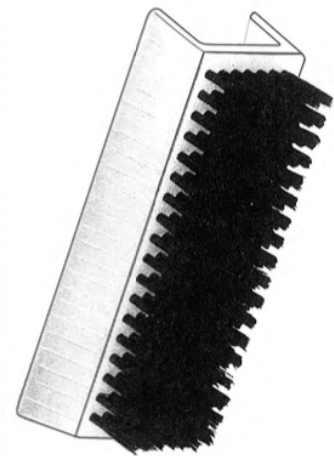

### CEPILLO SURGEONS

- 965-708** Con Canal posterior
- 965-710** Con Canal posterior, Paq. de 12



**MASTERMED**  
MASTERS EN PRODUCTOS MÉDICOS



**HOJAS ESTERILES - ENCAJA EN MANGOS No. 3, 3L, 3LA, 7, 9**

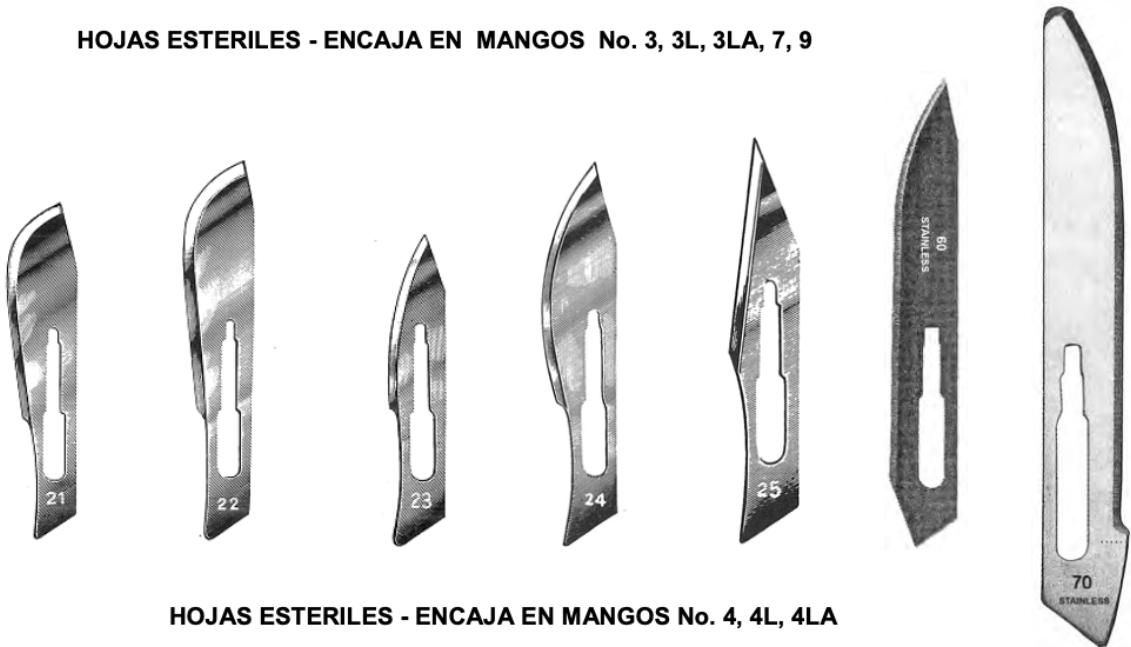

**HOJAS ESTERILES - ENCAJA EN MANGOS No. 4, 4L, 4LA**

### HOJAS DE BISTURI ESTERILES

**FEATHER Brand,**  
Caja de 100 Hojas  
Acero Inoxidable - Estéril

<b>052-496</b>	No. 10
<b>052-497</b>	No. 11
<b>052-498</b>	No. 12
<b>052-499</b>	No. 15
<b>052-500</b>	No. 20
<b>052-501</b>	No. 21
<b>052-502</b>	No. 22
<b>052-503</b>	No. 23
<b>052-504</b>	No. 24
<b>052-505</b>	No. 25
<b>052-506</b>	No. 60
<b>052-507</b>	No. 70

**CROWN FINE Brand,**  
Caja de 100 Hojas  
Acero Inoxidable - Estéril

<b>052-600</b>	No. 10
<b>052-602</b>	No. 11
<b>052-604</b>	No. 12
<b>052-606</b>	No. 15
<b>052-608</b>	No. 20
<b>052-610</b>	No. 21
<b>052-612</b>	No. 22
<b>052-614</b>	No. 23
<b>052-616</b>	No. 24
<b>052-618</b>	No. 25
<b>052-620</b>	No. 60
<b>052-622</b>	No. 70

**CROWN FINE Brand,**  
Caja de 100 Hojas  
Acero al Carbono - Estéril

<b>052-600-CS</b>	No. 10
<b>052-602-CS</b>	No. 11
<b>052-604-CS</b>	No. 12
<b>052-606-CS</b>	No. 15
<b>052-608-CS</b>	No. 20
<b>052-610-CS</b>	No. 21
<b>052-612-CS</b>	No. 22
<b>052-614-CS</b>	No. 23
<b>052-616-CS</b>	No. 24
<b>052-618-CS</b>	No. 25
<b>052-620-CS</b>	No. 60
<b>052-622-CS</b>	No. 70



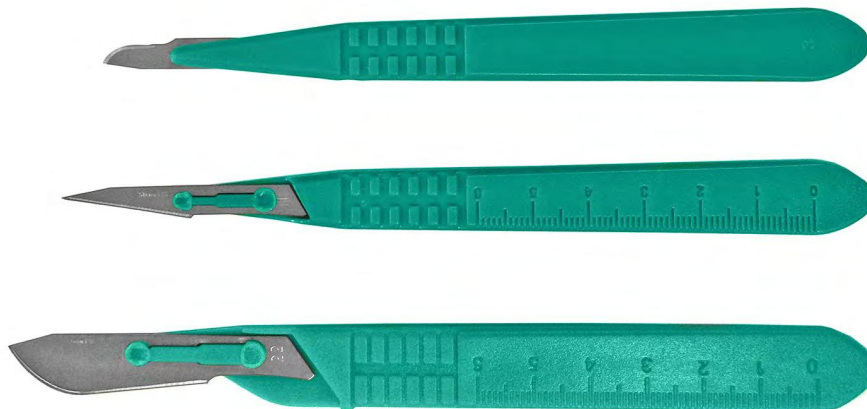

**HOJAS DE BISTURÍ - DESECHABLES  
ACERO INOXIDABLE- ESTERILES**  
(Empacadas y Selladas Individualmente)

- PA-1948-10** No. 10, Caja de 10,
- PA-1948-11** No. 11, Caja de 10,
- PA-1948-12** No. 12, Caja de 10,
- PA-1948-15** No. 15, Caja de 10,
- PA-1948-20** No. 20, Caja de 10,
- PA-1948-21** No. 21, Caja de 10,
- PA-1948-22** No. 22, Caja de 10,
- PA-1948-23** No. 23, Caja de 10,
- PA-1948-24** No. 24, Caja de 10

**HOJAS DE BISTURÍ - DESECHABLES  
ACERO INOXIDABLE SIN ESTIRILIZAR**

- DNS-10** No.10, Caja de 100,
- DNS-11** No.11, Caja de 100,
- DNS-12** No.12, Caja de 100,
- DNS-15** No.15, Caja de 100,
- DNS-20** No. 20, Caja de 100,
- DNS-21** No. 21, Caja de 100,
- DNS-22** No. 22, Caja de 100,
- DNS-23** No. 23, Caja de 100,
- DNS-24** No. 24, Caja de 100,
- DNS-60** No. 60, Mango largo, Caja de 100,
- DNS-70** No. 70, Caja de 100





**MASTERMED**  
MASTERS EN PRODUCTOS MÉDICOS



### CUCHILLO DERMATOLÓGICO

- 052-630** Cuchillo HUMBY Dermatológico, sin hojas, Largo 12 $\frac{1}{8}$ " (31 cm)
- 052-635** Hojas Dermatológicas HUMBY, Largo 158 mm, (Paquete de 10).



### HOJAS DESECHABLES DE BISTURÍ DE PULGAR ACERO INOXIDABLE

- MDNS-10** Hojas de Bisturi de pulgar, con mini mango de plástico, Caja de 100, No.10
- MDNS-11** Hojas de Bisturi de pulgar, con mini mango de plástico, Caja de 100, No.11
- MDNS-15** Hojas de Bisturi de pulgar, con mini mango de plástico, Caja de 100, No.15
- MDNS-60** Hojas de Bisturi de pulgar, con mini mango de plástico, Caja de 100, No. 60
- MDNS-70** Hojas de Bisturi de pulgar, con mini mango de plástico, Caja de 100, No.70

### CORTADOR DE PUNTADAS CON HOJAS DE ACERO INOXIDABLE

- SCNS-1948** Cortador de puntada, con mango de plástico, Caja de 100, sin esterilizar
- SCNS-1950** Cortador de puntada mini para mangos No.3, No.3L, No.7  
CAJA DE 100 (sellados individualmente.) ESTÉRIL
- SCNS-1960** Cortador de puntada largo 11 cm, Caja de 100, Estéril
- SCNS-1965** Cortador de puntada mediano, 9 cm, Caja de 100, Estéril
- SCNS-1970** Cortador de puntada estándar, 6.5 cm, Caja de 100, Estéril, Acero al Carbono



**MASTERMED**  
MASTERS EN PRODUCTOS MÉDICOS

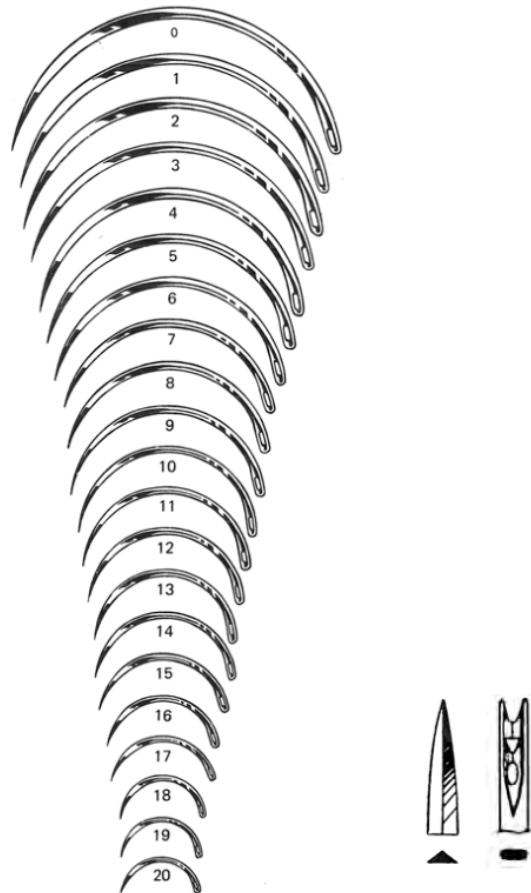

**AGUJAS PARA SUTURA CON OJO FRANCÉS (AUTOMÁTICO)**  
1/2 Circulo, Filo Cortante, Vendido en Paquetes de una Docena

<b>650-125-S</b>	No. 0	<b>650-143-S</b>	No. 9
<b>650-127-S</b>	No. 1	<b>650-145-S</b>	No. 10
<b>650-129-S</b>	No. 2	<b>650-147-S</b>	No. 11
<b>650-131-S</b>	No. 3	<b>650-149-S</b>	No. 12
<b>650-133-S</b>	No. 4	<b>650-151-S</b>	No. 13
<b>650-135-S</b>	No. 5	<b>650-153-S</b>	No. 14
<b>650-137-S</b>	No. 6	<b>650-155-S</b>	No. 15
<b>650-139-S</b>	No. 7	<b>650-157-S</b>	No. 16
<b>650-141-S</b>	No. 8		



**MASTERMED**  
MASTERS EN PRODUCTOS MÉDICOS

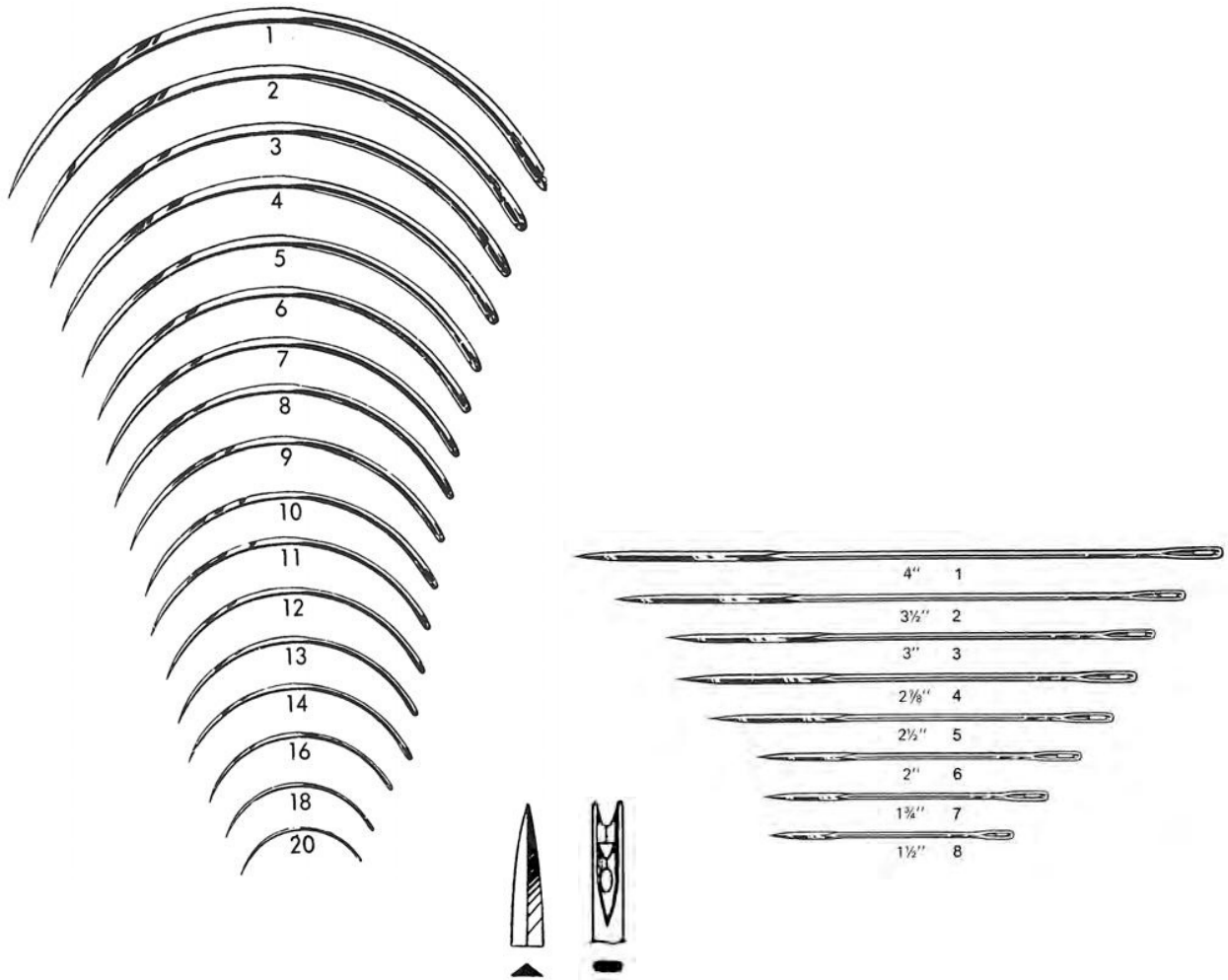

### **AGUJAS PARA SUTURA CON OJO FRANCÉS (AUTOMÁTICO)**

3/8 Circulo, Filo Cortante, Vendido en Paquetes de una Docena 650-

201-S No. 1 650-209-S No. 9  
650-202-S No. 2 650-210-S No. 10  
650-203-S No. 3 650-211-S No. 11  
650-204-S No. 4 650-212-S No. 12  
650-205-S No. 5 650-213-S No. 13  
650-206-S No. 6 650-214-S No. 14  
650-207-S No. 7 650-215-S No. 15  
650-208-S No. 8 650-216-S No. 16

### **AGUJAS KEITH ABDOMINAL, RECTA, TRIANGULAR, OJO FRANCÉS**

Vendido en Paquetes de una Docena

650-224-S No. 1 650-230-S No. 4  
650-226-S No. 2 650-232-S No. 5  
650-228-S No. 3 650-234-S No. 6



**MASTERMED**  
MASTERS EN PRODUCTOS MÉDICOS



### CONTENEDORES CON TAPA Y SIN MANIJA

<b>35-200</b>	Contenedores con Tapa y sin Manijas,	1 ¼ Qt. (1.18 L),	4 9/16" x 5 ¾" (11.6 x 14.6 cm)
<b>35-202</b>	Contenedores con Tapa y sin Manijas,	2 Qt. (1.89 L),	5 3/8" x 6 5/8" (13.8 x 16.8 cm)
<b>35-204</b>	Contenedores con Tapa y sin Manijas,	3 ¼ Qt. (3.07 L),	6 ½" x 7" (16.5 x 17.8 cm)
<b>35-206</b>	Contenedores con Tapa y sin Manijas,	4 ¾ Qt. (4.49 L),	7 3/8" x 8" (18.8 x 20.3 cm)
<b>35-208</b>	Contenedores con Tapa y sin Manijas,	6 ½ Qt. (5.79 L),	8" x 8 ¾" (20.3 x 22.2 cm)
<b>35-210</b>	Contenedores con Tapa y sin Manijas,	8 Qt. (7.57 L),	8 ¾" x 9 5/8" (22.2 x 24 cm)
<b>35-212</b>	Contenedores con Tapa y sin Manijas,	12 Qt. (11.35 L),	9 5/8" x 11" (24 x 27.9 cm)



### CONTENEDORES CON TAPA Y MANIJAS

<b>35-214</b>	Contenedores Con Tapa y Manijas,	8 Qt. (7.57 L),	9 ¾" x 7 5/8" (24.8 x 19.4 cm)
<b>35-216</b>	Contenedores Con Tapa y Manijas,	12 Qt. (11.35 L),	10 3/8" x 9" (26.4 x 22.9 cm)
<b>35-218</b>	Contenedores Con Tapa y Manijas,	16 Qt. (15.14 L),	13" x 9" (33 x 22.9 cm)
<b>35-220</b>	Contenedores Con Tapa y Manijas,	20 Qt. (18.92 L),	13" x 11" (33 x 27.9 cm)
<b>35-222</b>	Contenedores Con Tapa y Manijas,	24 Qt. (22.71 L),	13" x 13" (33 x 33 cm)
<b>35-224</b>	Contenedores Con Tapa y Manijas,	32 Qt. (30.28 L),	15" x 12 ½" (38 x 31.8 cm)
<b>35-226</b>	Contenedores Con Tapa y Manijas,	40 Qt. (37.85 L),	15" x 16" (38 x 40.6 cm)



**MASTERMED**  
MASTERS EN PRODUCTOS MÉDICOS



### CUBILITES AGITADOR

<b>35-228</b>	Cubilete Agitador,	4.22 Oz. (125 ml),	2 1/8" x 2 5/8" (5.4 x 6.7 cm)
<b>35-230</b>	Cubilete Agitador,	8.45 Oz. (250 ml),	2 5/8" x 3 1/4" (6.7 x 8.3 cm)
<b>35-232</b>	Cubilete Agitador,	20.28 Oz. (600 ml),	3 3/8" x 4 5/8" (8.6 x 11.8 cm)
<b>35-234</b>	Cubilete Agitador,	40.57 Oz. (1200 ml),	4 1/8" x 6 1/16" (10.5 x 15.4 cm)
<b>35-236</b>	Cubilete Agitador,	67.62 Oz. (2000 ml),	4 7/8" x 7 1/8" (12.4 x 18.1 cm)
<b>35-238</b>	Cubilete Agitador,	101.44 Oz. (3000 ml),	5 1/2" x 8 1/4" (14 x 21 cm)
<b>35-240</b>	Cubilete Agitador,	135.25 Oz. (4000 ml),	6 1/8" x 8 1/8" (15.5 x 20.6 cm)



### CUBETAS CON TAPA PARA SOLUCIÓN

<b>35-242</b>	Cubeta Con Tapa,	13 Qt. (12.30 L),	11 5/8" x 9 1/4" (29.5 x 23.5 cm)
<b>35-244</b>	Cubeta Con Tapa,	16 Qt. (15.14 L),	11 3/8" x 10 1/8" (28.9 x 25.7 cm)
<b>35-244-A</b>	Cubeta Con Tapa,	20 Qt. (18.92 L),	13 1/2" x 10 1/8" (34.3 x 25.7 cm)





**MASTERMED**  
MASTERS EN PRODUCTOS MÉDICOS



### CHAROLAS CON TAPA PARA INSTRUMENTAL

<b>35-245</b>	Charola P/Instrumental Con Tapa,	8 ½" x 5" x 2"	(21.6 x 12.7 x 5.1 cm)
<b>35-245-A</b>	Charola P/Instrumental Con Tapa,	12" x 7 ⅝" x 2"	(30.5 x 19.4 x 5.1 cm)
<b>35-246</b>	Charola P/Instrumental Con Tapa Plana,	12 ¼" x 7 ¾" x 2 ¼"	(31.1 x 19.7 x 5.7 cm)
<b>35-248</b>	Charola P/Instrumental Con Tapa Plana,	10" x 8 ¼" x 2 ½"	(25.4 x 21 x 6.4 cm)
<b>35-250</b>	Charola P/Instrumental Con Tapa Plana,	10" x 8 ¼" x 4"	(25.4 x 21 x 10.2 cm)
<b>35-252</b>	Charola P/Instrumental Con Tapa Plana,	16 ½" x 10" x 2 ½"	(41.9 x 25.4 x 6.4 cm)
<b>35-254</b>	Charola P/Instrumental Con Tapa Plana,	16 ½" x 10" x 4"	(41.9 x 25.4 x 10.2 cm)
<b>35-256</b>	Charola P/Instrumental Con Tapa Plana,	13 ⅞" x 12 ⅞" x 2 ½"	(35.2 x 32.7 x 6.4 cm)
<b>35-258</b>	Charola P/Instrumental Con Tapa Plana,	13 ⅞" x 12 ⅞" x 4"	(35.2 x 32.7 x 10.2 cm)
<b>35-259-P</b>	Cubierta P/Charolas Ovaladas,	12 ¼" x 10" x ⅝"	(31.1 x 25.4 x 1.6 cm)
<b>35-259-C</b>	Charola para Instr. C/Marco Ovalado,	11 ½" x 9 ¼" x 4"	(29.2 x 23.5 x 10.2 cm)



### JUEGOS DE CHAROLAS PARA ESTERILIZACIÓN PARA BAÑO Y CUBIERTAS PARA CHAROLAS

<b>35-260</b>	Charola de Esterilizacion, Solida,	20 ¾" x 12 ¾" x 4"	(52.7 x 32.4 x 10.2 cm)
<b>35-262</b>	Charola de Esterilizacion, Perforada,	20 ¾" x 12 ¾" x 2 ½"	(52.7 x 32.4 x 6.4 cm).
<b>35-264</b>	Charola de Esterilizacion, Solida,	20 ¾" x 12 ¾" x 6"	(52.7 x 32.4 x 15.2 cm)
<b>35-266</b>	Charola de Esterilizacion, Perforada,	20 ¾" x 12 ¾" x 4"	(52.7 x 32.4 x 10.2 cm)
<b>35-268</b>	Charola de Esterilizacion, Solida,	12 ¾" x 10 ⅜" x 4"	(32.4 x 26.4 x 10.2 cm)
<b>35-270</b>	Charola de Esterilizacion, Perforada,	12 ¾" x 10 ⅜" x 2 ½"	(32.4 x 26.4 x 6.4 cm)
<b>35-272</b>	Charola de Esterilizacion, Solida,	12 ¾" x 10 ⅜" x 6"	(32.4 x 26.4 x 15.2 cm)
<b>35-274</b>	Charola de Esterilizacion, Perforada,	12 ¾" x 10 ⅜" x 4"	(32.4 x 26.4 x 10.2 cm)
<b>35-276</b>	Cubierta Solida para Charolas de Esterilizacion, adaptado para GS-35-260 to GS-35-266		
<b>35-278</b>	Cubierta Solida para Charolas de Esterilizacion adaptado para GS-35-268 to GS-35-274		

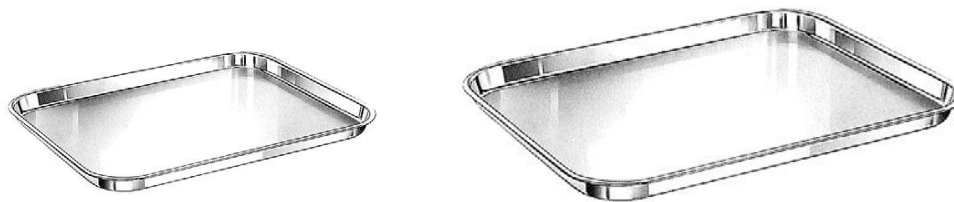

### CHAROLAS DE MEDICAMENTO PARA CAMA

- 35-280** Charola de Medicamento P/Cama, 10" x 6 1/2" x 3/4" (25.4 x 16.5 x 1.9 cm)  
**35-282** Charola de Medicamento P/Cama, 13 11/16" x 9 13/16" x 3/4" (34.8 x 24.9 x 1.9 cm).



### JARRAS DE LADOS RECTOS

- 35-284** Jarra de Lado Recto, 2 Qt. (1.89 L), 5 1/6" x 6 5/8" (13 x 16.8 cm)  
**35-286** Jarra de Lado Recto, 3 Qt. (2.83 L), 6 1/6" x 7" (15.7 x 17.8 cm)



### VASOS METÁLICOS

- 35-288** Vaso Metalico, 7 Oz. (207.01 ml), 2 7/8" x 3 1/8" (7.3 x 8 cm)  
**35-290** Vaso Metalico, 12 Oz. (354.88 ml), 3 3/16" x 4" (8 x 10.2 cm)





**MASTERMED**  
MASTERS EN PRODUCTOS MÉDICOS



### CHAROLAS (BANDEJAS) MAYO CON PERFORACIÓN

<b>35-298</b>	Charola MAYO con Perforación,	10" x 6 1/2" x 3/4"	(25.4 x 16.5 x 1.9 cm)
<b>35-299</b>	Charola MAYO con Perforación,	13 1/2" x 9 3/4" x 3/4"	(34.3 x 24.8 x 1.9 cm)
<b>35-300</b>	Charola MAYO con Perforación,	15 1/2" x 10 5/8" x 3/4"	(39.4 x 27 x 1.9 cm)
<b>35-301</b>	Charola MAYO con Perforación,	17" x 11 5/8" x 3/4"	(43.2 x 29.5 x 1.9 cm)
<b>35-302</b>	Charola MAYO con Perforación,	19 1/2" x 12 5/8" x 3/4"	(49.5 x 32.1 x 1.9 cm)
<b>35-302-A</b>	Charola MAYO con Perforación,	21 1/4" x 16 1/4" x 3/4"	(54 x 41.3 x 1.9 cm)



### CHAROLAS (BANDEJAS) MAYO SIN PERFORACIÓN

<b>35-303</b>	Charola MAYO sin Perforación,	10" x 6 1/2" x 3/4"	(25.4 x 16.5 x 1.9 cm)
<b>35-304</b>	Charola MAYO sin Perforación,	13 1/2" x 9 3/4" x 3/4"	(34.3 x 24.8 x 1.9 cm)
<b>35-305</b>	Charola MAYO sin Perforación,	15 1/2" x 10 5/8" x 3/4"	(39.4 x 27 x 1.9 cm)
<b>35-306</b>	Charola MAYO sin Perforación,	17" x 11 5/8" x 3/4"	(43.2 x 29.5 x 1.9 cm)
<b>35-307</b>	Charola MAYO sin Perforación,	19 1/2" x 12 5/8" x 3/4"	(49.5 x 32.1 x 1.9 cm)
<b>35-308</b>	Charola MAYO sin Perforación,	21 1/4" x 16 1/8" x 3/4"	(54 x 41.3 x 1.9 cm)
<b>35-308-A</b>	Charola MAYO sin Perforación, con borde plano	25" x 15" x 5/8"	(63.5 x 38 x 1.6 cm)



### CHAROLAS PARA CATÉTERS CON CUBIERTA OVALADA

<b>35-309</b>	Charola para Catéteres con Cubierta Ovalada,	8 ¾" x 3 ¼" x 1 ½"	(22.2 x 8.3 x 3.8 cm)
<b>35-310</b>	Charola para Catéteres con Cubierta Ovalada,	8 ⅞" x 5" x 2"	(22.5 x 12.7 x 5 cm)
<b>35-311</b>	Charola para Catéteres con Cubierta Ovalada,	8 ⅞" x 5" x 3"	(22.5 x 12.7 x 7.6 cm)
<b>35-311-A</b>	Charola para Catéteres con Cubierta Ovalada,	12 ½" x 3 ¾" x 1 ¾"	(31.8 x 9.5 x 4.5 cm)
<b>35-312</b>	Charola para Catéteres con Cubierta Ovalada,	17 ¼" x 4 ½" x 2"	(43.8 x 11.4 x 5 cm)



### BANDEJAS PARA CATÉTERS CON CUBIERTA PLANA CON MANIJA INCRUSTADA

<b>35-313</b>	Bandejas para Catéteres con Cubierta Plana,	12¾" x 7¾" x 2¼",	(32.4 cm x 19.7 cm x 5.7 cm)
---------------	---------------------------------------------	-------------------	------------------------------



### BANDEJAS PROFUNDAS CON PERFORACIÓN

<b>35-314</b>	Bandejas Profundas con Perforación,	8 ⅞" x 5" x 2"	(22.5 x 12.7 x 5.1 cm)
<b>35-315</b>	Bandejas Profundas con Perforación,	10" x 6 ½" x 2"	(25.4 x 16.5 x 5.1 cm)
<b>35-316</b>	Bandejas Profundas con Perforación,	12 ¼" x 7 ¾" x 2¼"	(31.1 x 19.7 x 5.7 cm)
<b>35-317</b>	Bandejas Profundas con Perforación,	12 ¾" x 10 ⅞" x 2 ½"	(32.4 x 26.4 x 6.4 cm)
<b>35-318</b>	Bandejas Profundas con Perforación,	16 ½" x 10" x 2 ½"	(42 x 25.4 x 6.4 cm)
<b>35-318-A</b>	Bandejas Profundas con Perforación,	17 ¾" x 12 ¾" x 2 ½"	(45 x 32.4 x 6.4 cm)
<b>35-319</b>	Bandejas Profundas con Perforación,	20 ¾" x 12 ¾" x 2 ½"	(52.7 x 32.4 x 6.4 cm)



**MASTERMED**  
MASTERS EN PRODUCTOS MÉDICOS



### CHAROLAS (BANDEJAS) PROFUNDAS SIN PERFORACIÓN

<b>35-314-NP</b>	Charola Profunda sin Perforación,	8 $\frac{7}{8}$ " x 5" x 2"	(22.5 x 12.7 x 5.1 cm)
<b>35-315-NP</b>	Charola Profunda sin Perforación,	10" x 6 $\frac{1}{2}$ " x 2"	(25.4 x 16.5 x 5.1 cm)
<b>35-316-NP</b>	Charola Profunda sin Perforación,	12 $\frac{1}{4}$ " x 7 $\frac{3}{4}$ " x 2 $\frac{1}{4}$ "	(31.1 x 19.7 x 5.7 cm)
<b>35-317-NP</b>	Charola Profunda sin Perforación,	12 $\frac{1}{2}$ " x 8 $\frac{1}{2}$ " x 1 $\frac{1}{4}$ "	(31.8 x 21.6 x 3.2 cm)

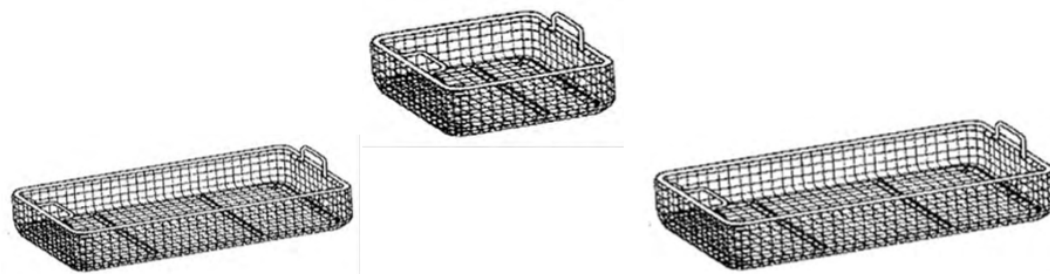

### CHAROLAS DE ALAMBRE PARA ESTERILIZACIÓN

<b>35-320</b>	Charola de Alambre para Esterilización,	9 $\frac{7}{16}$ " x 9 $\frac{27}{32}$ " x 1 $\frac{31}{32}$ "	(24 x 25 x 5 cm)
<b>35-321</b>	Charola de Alambre para Esterilización,	9 $\frac{7}{16}$ " x 9 $\frac{27}{32}$ " x 2 $\frac{3}{4}$ "	(24 x 25 x 7 cm)
<b>35-322</b>	Charola de Alambre para Esterilización,	9 $\frac{7}{16}$ " x 10" x 1 $\frac{31}{32}$ "	(24 x 25.4 x 5 cm)
<b>35-323</b>	Charola de Alambre para Esterilización,	18 $\frac{7}{8}$ " x 9 $\frac{27}{32}$ " x 1 $\frac{31}{32}$ "	(48 x 25 x 5 cm)
<b>35-324</b>	Charola de Alambre para Esterilización,	18 $\frac{7}{8}$ " x 9 $\frac{27}{32}$ " x 2 $\frac{3}{4}$ "	(48 x 25 x 7 cm)
<b>35-325</b>	Charola de Alambre para Esterilización,	18 $\frac{7}{8}$ " x 9 $\frac{27}{32}$ " x 3 $\frac{15}{16}$ "	(48 x 25 x 10 cm)
<b>35-326</b>	Charola de Alambre para Esterilización,	18 $\frac{7}{8}$ " x 10" x 1 $\frac{31}{32}$ "	(48 x 25.4 x 5 cm)
<b>35-327</b>	Charola de Alambre para Esterilización,	20 $\frac{1}{16}$ " x 10" x 1 $\frac{31}{32}$ "	(51 x 25.4 x 5 cm)
<b>35-328</b>	Charola de Alambre para Esterilización,	9 $\frac{7}{16}$ " x 9 $\frac{27}{32}$ " x 2 $\frac{3}{8}$ "	(24 x 25 x 6 cm)
<b>35-329</b>	Charola de Alambre para Esterilización,	18 $\frac{7}{8}$ " x 9 $\frac{27}{32}$ " x 2 $\frac{3}{8}$ "	(48 x 25 x 6 cm)

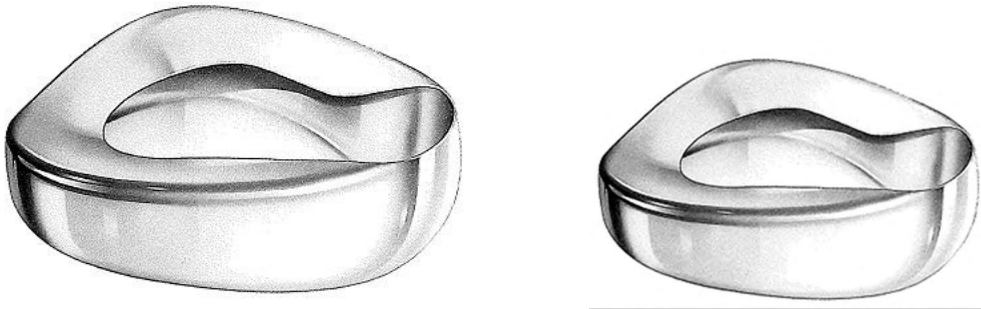
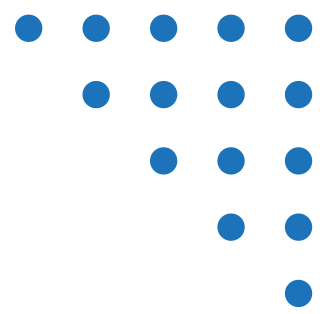

### COMODOS

**35-330** Comodos, Tamaño Adulto, 13 ¾" x 11 ½" x 4" (34.9 x 29.2 x 10.2 cm)

**35-333** Comodos, Tamaño Pediátrico, 12 ⅛" x 9 ¾" x 3" (30.8 x 24.8 x 7.6 cm)



### COMODOS TIPO CUNA

**35-335** Comodos Tipo Cuna, 11 ⅞" x 9 ½" x 2 ⅞" (30.1 x 24.1 x 7.3 cm)



### MALE AND FEMALE URINALS

**35-336** Orinal Masc. Horizontal/Vertical, 1 ¾ Qt. (1.65 L), 11 ½" x 9 ⅛" (11.4 x 23.2 cm)

**35-337** Orinal Masc. Vertical Solamente, 1 ½ Qt. (1.42 L), 11 ½" x 9 ⅛" (11.4 x 23.2 cm)

**35-337-F** Orinal Femenino, Tamaño, 0.64 Qt. (0.61 L), 5 ½" x 8 ¾" (14 x 22.2 cm)





**MASTERMED**  
MASTERS EN PRODUCTOS MÉDICOS



### CHAROLAS RIÑONERAS

<b>35-338</b>	Charola Riñonera, pequeña,	10 Oz. (295.73 ml),	6 <sup>5</sup> / <sub>8</sub> " x 3 <sup>1</sup> / <sub>2</sub> " x 1 <sup>1</sup> / <sub>2</sub> "	(16.8 x 8.9 x 3.8 cm)
<b>35-339</b>	Charola Riñonera, Mediano,	12 Oz. (354.88 ml),	8 <sup>1</sup> / <sub>8</sub> " x 3 <sup>5</sup> / <sub>8</sub> " x 1 <sup>5</sup> / <sub>8</sub> "	(20.6 x 9.2 x 4.1 cm)
<b>35-340</b>	Charola Riñonera, Grande,	26 Oz. (768.91 ml),	9 <sup>7</sup> / <sub>8</sub> " x 4 <sup>1</sup> / <sub>2</sub> " x 2 <sup>1</sup> / <sub>8</sub> "	(25 x 11.4 x 5.4 cm)
<b>35-341</b>	Charola Riñonera, X/Grande,	48 Oz. (1419.53 ml),	12" x 5 <sup>1</sup> / <sub>2</sub> " x 2 <sup>3</sup> / <sub>8</sub> "	(30.5 x 14 x 6.1 cm)



### PORTA TERMOMETROS/PORTA-BATE LENGUAS PORTA PINZA

<b>35-342</b>	Porta Instrumentos, Pequeño,	2 <sup>1</sup> / <sub>4</sub> " x 4 <sup>1</sup> / <sub>4</sub> "	(5.7 x 10.8 cm)
<b>35-343</b>	Porta Instrumentos, Grande,	2 <sup>1</sup> / <sub>4</sub> " x 7"	(5.7 x 17.8 cm)
<b>35-344</b>	Porta Termómetros,	1" x 4"	(2.5 x 10.2 cm)
<b>35-345</b>	Jarra de Aplicador con Tapa,	3 <sup>1</sup> / <sub>8</sub> " x 7"	(8 x 17.8 cm)

28 Oz. (828 ml),



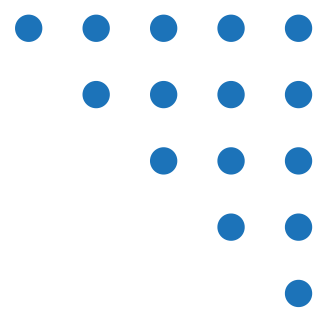

### JABONERAS ESTERILIZADORAS

**35-347** Jabonera Esterilizadora, 5 ½" x 4 ⅛" x 1 ⅛", (14 cm x 10.5 cm x 2.9 cm)



### PALANGANAS LAVAMANOS

**35-348** Palangana-Lavamanos, 4 Qt. (3.78 ml), 12 ¾" x 3 ¾" (31.5 x 9.5 cm)

**35-349** Palangana-Lavamanos, 4 ⅞ Qt. (4.62 ml), 13 ¼" x 3 ½" (33.7 x 8.9 cm)



### YODEROS

**35-350** Yodero, Pequeño, 6 Oz. (177.44 ml) 3 7/16" x 2" (8.7 x 5.1 cm)

**35-355** Yodero, Grande, 14 Oz. (414.02 ml) 4 ¾" x 2 ⅝" (12.1 x 6.7 cm)





**MASTERMED**  
MASTERS EN PRODUCTOS MÉDICOS



### ESTUCHES PARA ESTERILIZAR AGUJAS

- 35-357** Para esterilizar agujas con diametro de. 6.5 x 1.5 cm altura, Con camara interna perforada  
**35-358** Camara Interior perforada solamente



### VASOS GRADUADOS

- 35-360** Vaso Graduado, 2 Oz. (59.14 ml), 2 1/8" x 2" (5.4 x 5.1 cm)



### JARRAS GRADUADAS

- |               |                   |                       |                                  |
|---------------|-------------------|-----------------------|----------------------------------|
| <b>35-362</b> | Jarras Graduadas, | 16 Oz. (473.17 ml),   | 3 3/4" x 4 5/8" (9.5 x 11.8 cm)  |
| <b>35-365</b> | Jarras Graduadas, | 32 Oz . (946.35 ml),  | 4 3/4" x 5 1/4" (12.1 x 13.3 cm) |
| <b>35-368</b> | Jarras Graduadas, | 64 Oz . (1892.71 ml), | 5 1/2" x 6 1/2" (14 x 16.5 cm).  |





### PINZAS DE TRASLADO

**35-369** Pinza de Traslado, Agarradera Tipo Pistola, Acero Inoxidable



### PORTA CUBETAS RODABLE DE ACERO INOXIDABLE

- 35-370** Porta Cubeta rodable de acero inoxidable, 13 Qt. (12.30 L)
- 35-370-A** Porta Cubeta rodable de acero inoxidable, 16 Qt. (15.14 L)
- 35-370-B** Solamente Stand para la cubeta
- 35-370-C** Cubeta de Acero Inoxidable, 13 Qt. (12.30 L), 11 <sup>3</sup>/<sub>4</sub>" x 9 <sup>1</sup>/<sub>4</sub>" (29.9 x 23.5 cm)
- 35-370-D** Cubeta de Acero Inoxidable, 16 Qt. (15.14 L), 11 <sup>3</sup>/<sub>4</sub>" x 10 <sup>1</sup>/<sub>8</sub>" (29.9 x 25.7 cm)
- 35-370-E** Cubeta de Acero Inoxidable, 20 Qt. (18.92 L), 13 <sup>3</sup>/<sub>4</sub>" x 11 **13**/<sub>16</sub>" (35 x 30 cm)



### TORUNDEROS CON TAPA

- 35-371** Torundero Con Tapa con agarradera, 9 Oz. (266.10 ml), 3 <sup>1</sup>/<sub>8</sub>" x 2 <sup>3</sup>/<sub>4</sub>" (8 x 7 cm)
- 35-372** Torundero Con Tapa sin agarradera, 9 Oz. (266.10 ml), 3 <sup>1</sup>/<sub>8</sub>" x 2 <sup>3</sup>/<sub>4</sub>" (8 x 7 cm)



**MASTERMED**  
MASTERS EN PRODUCTOS MÉDICOS



### PALANGANAS PARA SOLUCIÓN

<b>35-375</b>	Palangana para Solución,	5 Qt. (4.7 L),	12" x 4¼" x 11¼"	(30.5 x 10.8 x 28.5 cm)
<b>35-376</b>	Palangana para Solución,	5½ Qt. (5.3 L),	12¼" x 4¾" x 11¾"	(31.1 x 11.1 x 30.1 cm)
<b>35-377</b>	Palangana para Solución,	7 Qt. (6.6 L),	13¾" x 4¾" x 13¾"	(34.6 x 11.7 x 33.3 cm)
<b>35-378</b>	Palangana para Solución,	8½ Qt. (8 L),	14½" x 4¾" x 13¾"	(36.8 x 12 x 35.2 cm)



### PALANGANAS PARA GAZA

<b>35-381</b>	Palangana para Gaza,	12 Oz. (354.88 ml),	4 ¼" x 2"	(10.8 x 5.1 cm)
<b>35-382</b>	Palangana para Gaza,	22 Oz. (650.61 ml),	5" x 2 ¾"	(12.7 x 6.1 cm)
<b>35-383</b>	Palangana para Gaza,	29 Oz. (857.63 ml),	5 9/16" x 2 9/16"	(14.1 x 6.5 cm)
<b>35-384</b>	Palangana para Gaza,	36 Oz. (1064.65 ml),	6 ¼" x 2 ¾"	(15.9 x 7 cm)
<b>35-385</b>	Palangana para Gaza,	48 Oz. (1419.53 ml),	7 ½" x 2 ¾"	(18 x 7 cm)
<b>35-386</b>	Palangana para Gaza,	64 Oz. (1892.71 ml),	7 9/16" x 3"	(19 x 7.6 cm)

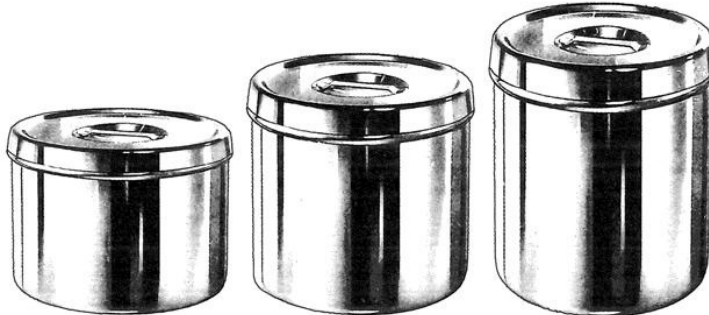

### TORUNDEROS CON TAPA

<b>35-390</b>	Torundero Con Tapa,	½ Qt. (0.47 L),	4 ⅛" x 2 ¼"	(10.5 x 5.7 cm)
<b>35-391</b>	Torundero Con Tapa,	1 ¼ Qt. (1.18 L),	4 ⅞" x 5 ½"	(10.5 x 14 cm)
<b>35-392</b>	Torundero Con Tapa,	1 ⅞ Qt. (1.77 L),	4 ⅞" x 6 ¼"	(12.3 x 15.9 cm)
<b>35-393</b>	Torundero Con Tapa,	3 Qt. (2.83 L),	5 ⅞" x 6 ¾"	(14.9 x 17.1 cm)
<b>35-394</b>	Torundero Con Tapa,	4 ¾ Qt. (4.49 L),	6 ¾" x 7 ¾"	(17.1 x 19.7 cm)
<b>35-395</b>	Torundero Con Tapa,	6 Qt. (5.67 L),	7 ¼" x 8 ¾"	(18.4 x 21.3 cm)
<b>35-396</b>	Torundero Con Tapa,	8 Qt. (7.57 L),	8" x 9 ¾"	(20.3 x 23.9 cm)



**MASTERMED**  
MASTERS EN PRODUCTOS MÉDICOS



### CAJAS PARA ESTERILIZAR CON TAPA SIN ASA

<b>35-406</b>	Caja Para Esterilizar Con Tapa, Sin Asa,	7" x 3" x 1 ½"	(17.8 x 7.6 x 3.8 cm).
<b>35-406-A</b>	Caja Para Esterilizar Con Tapa, Sin Asa,	8" x 3 ½" x 1 ½"	(20.3 x 8.9 x 3.8 cm)
<b>35-407</b>	Caja Para Esterilizar Con Tapa, Sin Asa,	8" x 4" x 2"	(20.3 x 10.2 x 5.1 cm)
<b>35-407-A</b>	Caja Para Esterilizar Con Tapa, Sin Asa,	9" x 5" x 2"	(22.9 x 12.7 x 5.1 cm)
<b>35-408</b>	Caja Para Esterilizar Con Tapa, Sin Asa,	10" x 4" x 2"	(25.4 x 10.2 x 5.1 cm)
<b>35-409</b>	Caja Para Esterilizar Con Tapa, Sin Asa,	10" x 5" x 2"	(25.4 x 12.7 x 5.1 cm)
<b>35-410</b>	Caja Para Esterilizar Con Tapa, Sin Asa,	12" x 6" x 2"	(30.5 x 15.2 x 5.1 cm)
<b>35-411</b>	Caja Para Esterilizar Con Tapa, Sin Asa,	12" x 6" x 3"	(30.5 x 15.2 x 7.6 cm)
<b>35-506</b>	Caja Para Esterilizar Con Tapa, Sin Asa,	13" x 6" x 2"	(33 x 15.2 x 5.1 cm)
<b>35-506-A</b>	Surgical.Box With Cover, Without Knob,	13½" x 6½" x 2½"	(34.2 x 16.5 x 6.4 cm)
<b>35-506-B</b>	Caja Para Esterilizar Con Tapa, Sin Asa,	13 ½" x 8" x 5"	(34.2 x 20.3 x 12.7 cm)
<b>35-507</b>	Caja Para Esterilizar Con Tapa, Sin Asa,	14" x 6" x 3"	(35.6 x 15.2 x 7.6 cm)
<b>35-508</b>	Caja Para Esterilizar Con Tapa, Sin Asa,	12" x 8" x 2"	(30.5 x 20.3 x 5.1 cm)
<b>35-509</b>	Caja Para Esterilizar Con Tapa, Sin Asa,	16" x 8" x 4"	(40.6 x 20.3 x 10.2 cm)
<b>35-510</b>	Caja Para Esterilizar Con Tapa, Sin Asa,	18" x 8" x 4"	(45.7 x 20.3 x 10.2 cm)
<b>35-511</b>	Caja Para Esterilizar Con Tapa, Sin Asa,	20" x 8" x 4"	(50.8 x 20.3 x 10.2 cm)



### CAJAS PARA ESTERILIZAR CON TAPA Y ASA

- 35-412** Caja Para Esterilizar Con Tapa y Asa, 7" x 3" x 1 ½" (17.8 x 7.6 x 3.8 cm)
- 35-414** Caja Para Esterilizar Con Tapa y Asa, 8" x 3 ½" x 2" (20.3 x 8.9 x 5.1 cm).
- 35-416** Caja Para Esterilizar Con Tapa y Asa, 10" x 4" x 2" (25.4 x 10.2 x 5.1 cm)
- 35-418** Caja Para Esterilizar Con Tapa y Asa, 12" x 5" x 2" (30.5 x 12.7 x 5.1 cm).
- 35-420** Caja Para Esterilizar Con Tapa y Asa, 12" x 6" x 3" (30.5 x 15.2 x 7.6 cm).



**MASTERMED**  
MASTERS EN PRODUCTOS MÉDICOS



### TAMBORES VERTICALES PARA ESTERILIZACIÓN

<b>35-425</b>	Tambor Vertical para Esterilización, Con Ventilación,	6" x 6"	(15.2 x 15.2 cm)
<b>35-426</b>	Tambor Vertical para Esterilización, Con Ventilación,	7" x 7"	(17.8 x 17.8 cm)
<b>35-427</b>	Tambor Vertical para Esterilización, Con Ventilación,	9" x 4 1/2"	(22.9 x 11.4 cm)
<b>35-428</b>	Tambor Vertical para Esterilización, Con Ventilación,	9" x 9"	(22.9 x 22.9 cm)
<b>35-429</b>	Tambor Vertical para Esterilización, Con Ventilación,	9" x 6"	(22.9 x 15.2 cm)
<b>35-430</b>	Tambor Vertical para Esterilización, Con Ventilación,	11" x 9 3/4"	(27.9 x 24.8 cm)
<b>35-431</b>	Tambor Vertical para Esterilización, Con Ventilación,	12" x 10"	(30.5 x 25.4 cm)
<b>35-432</b>	Tambor Vertical para Esterilización, Con Ventilación,	14" x 10"	(35.6 x 25.4 cm)
<b>35-433</b>	Tambor Vertical para Esterilización, Con Ventilación,	15" x 12"	(38 x 30.5 cm)
<b>35-434</b>	Tambor Vertical para Esterilización, Sin Ventilación,	4" x 4"	(10.2 x 10.2 cm)
<b>35-435</b>	Tambor Vertical para Esterilización, Sin Ventilación,	4" x 4 3/4"	(10.2 x 12.1 cm)
<b>35-436</b>	Tambor Vertical para Esterilización, Sin Ventilación,	6" x 4 3/4"	(15.2 x 12.1 cm)
<b>35-437</b>	Tambor Vertical para Esterilización, Sin Ventilación,	7 3/4" x 5 1/2"	(19.7 x 14 cm)





**MASTERMED**  
MASTERS EN PRODUCTOS MÉDICOS



### PALANGANAS TIPO "J"

<b>35-450</b>	Palangana Tipo "J",	2 Oz.	(59.14 ml)
<b>35-452</b>	Palangana Tipo "J",	3 Oz.	(88.72 ml)
<b>35-454</b>	Palangana Tipo "J",	4 Oz.	(118.29 ml)
<b>35-456</b>	Palangana Tipo "J",	6 Oz.	(177.44 ml)
<b>35-458</b>	Palangana Tipo "J",	8 Oz.	(236.58 ml)
<b>35-460</b>	Palangana Tipo "J",	10 Oz.	(295.73 ml)
<b>35-462</b>	Palangana Tipo "J",	12 Oz.	(354.88 ml)



### PALANGANAS PARA MEZCLAR

<b>35-464</b>	Palangana para Mezclar,	$\frac{1}{8}$ Qt.	(0.82 L),	6 $\frac{5}{8}$ " x 2 $\frac{1}{2}$ ",	(16.8 x 6.4 cm)
<b>35-466</b>	Palangana para Mezclar,	1 $\frac{1}{8}$ Qt.	(1.53 L),	8 $\frac{1}{8}$ " x 3",	(20.6 x 7.6 cm)
<b>35-468</b>	Palangana para Mezclar,	3 Qt.	(2.83 L),	9 $\frac{3}{4}$ " x 4",	(24.8 x 10.2 cm)
<b>35-470</b>	Palangana para Mezclar,	5 Qt.	(4.73 L),	11 $\frac{7}{8}$ " x 4 $\frac{1}{2}$ ",	(30.1 x 11.4 cm)
<b>35-472</b>	Palangana para Mezclar,	6 $\frac{3}{4}$ Qt.	(6.38 L),	12 $\frac{3}{4}$ " x 5 $\frac{1}{4}$ ",	(32.4 x 13.3 cm)
<b>35-474</b>	Palangana para Mezclar,	8 Qt.	(7.57 L),	13 $\frac{5}{16}$ " x 5 $\frac{7}{16}$ ",	(33.8 x 13.8 cm)
<b>35-476</b>	Palangana para Mezclar,	13 $\frac{1}{2}$ Qt.	(12.77 L),	16 $\frac{1}{4}$ " x 6",	(41.2 x 15.2 cm)



**MASTERMED**  
MASTERS EN PRODUCTOS MÉDICOS

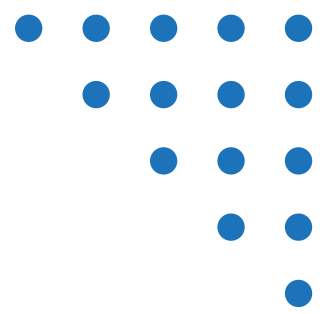

### TAPAS CILÍNDRICAS

<b>35-478</b>	Tapas Cilíndricas P/Frascos,	2 <sup>7</sup> / <sub>8</sub> "	( 7.3 cm)
<b>35-480</b>	Tapas Cilíndricas P/Frascos,	3 <sup>47</sup> / <sub>64</sub> "	(9.5 cm)
<b>35-482</b>	Tapas Cilíndricas P/Frascos,	4 <sup>11</sup> / <sub>64</sub> "	(10.6 cm)
<b>35-484</b>	Tapas Cilíndricas P/Frascos,	4 <sup>11</sup> / <sub>16</sub> "	(11.9 cm)
<b>35-486</b>	Tapas Cilíndricas P/Frascos,	5 <sup>5</sup> / <sub>8</sub> "	(14.3 cm)



### IRRIGADORES CON MANIJA

- 35-700** Irrigador con Manija, 1.05 Qt. (1 L)
- 35-702** Irrigador con Manija, 1.50 Qt. (1.58 L)
- 35-704** Irrigador con Manija, 2 Qt. (2.11 L)

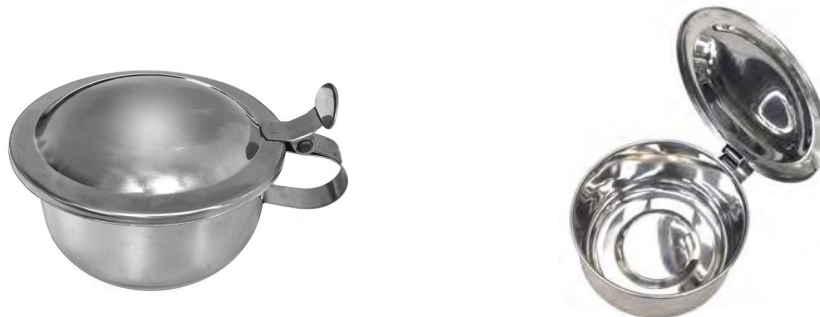

### TAZAS CON TAPAS

- 35-706** Taza con Tapa, 12 Oz. (354.88 ml), 3 <sup>15</sup>/<sub>16</sub>" x 1 <sup>49</sup>/<sub>64</sub>" (10 x 4.5 cm)





### PLATOS PARA PLACENTA

**35-712** Plato para Placenta con Cubierta

**35-714** Plato para Placenta sin Cubierta



### CARROS DE SERVICIO CON TRES NIVELES

**35-720** Pequeño, Largo 75 cm., Ancho 50 cm., Altura 90 cm

**35-722** Mediano, Largo 91 cm., Ancho 57 cm., Altura 110 cm

**35-723** Grande, Largo 91 cm., Ancho 52 cm., Altura 120 cm



## SET DE INSTRUMENTOS PARA VETERINARIO

GS-036-730 PAQUETE CANINO - 15 Instrumentos, Calidad Alemán

036-730 PAQUETE CANINO - 15 Instrumentos, Calidad Pakistán

- 1 Tijera Mayo, 6<sup>3</sup>/<sub>4</sub>" Recta (17.1cm)
- 1 Bisturí #3
- 2 Pinza Halstead Mosquito, 5" Curva (12.7cm)
- 2 Pinza Hemostática Kelly, 5<sup>1</sup>/<sub>2</sub>" Recta (14cm)
- 2 Pinza Hemostática Kelly, 5<sup>1</sup>/<sub>2</sub>" Curva (14cm)
- 3 Pinza de Campo Backhaus, 3<sup>1</sup>/<sub>2</sub>" (8.9cm)
- 1 Porta Arujas Olsen-Hegar, 6<sup>1</sup>/<sub>2</sub>" (16.5cm)
- 1 Pinza Adson-Brown, 4<sup>3</sup>/<sub>4</sub>" 9x9 (12.1cm)
- 1 Pinza Allis, 6" 4x5T (15.2cm)
- 1 Gancho

GS-036-732 PAQUETE FELINO - 14 Instrumentos, Calidad Alemán

036-732 PAQUETE FELINO - 14 Instrumentos, Calidad Pakistán

- 1 Tijera Mayo, 6<sup>3</sup>/<sub>4</sub>" Recta (17.1cm)
- 1 Bisturí #3
- 2 Pinza Halstead Mosquito, 5" Recta (12.7cm)
- 2 Pinza Halstead Mosquito, 5" Curva (12.7cm)
- 2 Pinza Hemostática Kelly, 5<sup>1</sup>/<sub>2</sub>" Curva (14cm)
- 3 Pinza de Campo Backhaus, 3<sup>1</sup>/<sub>2</sub>" (8.9cm)
- 1 Porta Arujas Olsen-Hegar, 6<sup>1</sup>/<sub>2</sub>" 16.5cm)
- 1 Pinza Adson-Brown, 4<sup>3</sup>/<sub>4</sub>" 9x9 (12.1cm)
- 1 Gancho

GS-036-734 PAQUETE DE CIRUJIA GENERAL - 19 Instrumentos, Calidad Alemán

036-734 PAQUETE DE CIRUJIA GENERAL - 19 Instrumentos, Calidad Pakistán

- 1 Tijera Mayo, 6<sup>3</sup>/<sub>4</sub>" Recta (17.1cm)
- 1 Tijera Metzenbaum, 7" Curva (17.8cm)
- 1 Bisturí #3
- 3 Pinza Halstead Mosquito, 5" Curva (12.7cm)
- 2 Pinza Hemostática Kelly, 5<sup>1</sup>/<sub>2</sub>" Recta (14cm)
- 4 Pinza Rochester-Carmalt, 6<sup>3</sup>/<sub>4</sub>" Curva (15.9cm)
- 4 Pinza de Campo Backhaus, 3<sup>1</sup>/<sub>2</sub>" (8.9cm)
- 1 Porta Arujas Olsen-Hegar, 6<sup>1</sup>/<sub>2</sub>" (16.5cm)
- 1 Pinza Adson-Brown, 4<sup>3</sup>/<sub>4</sub>", 7x7 (12.1cm)
- 1 Gancho

## ESTUCHES PARA ESTUDIANTE

### 040-405-11 Estuche de Disección con 11 Instrumentos

K-02-492 1 Mango de Bisturí, #4  
K-11-107 S/B 1 Tijeras Quirúrgicas, Aguda/Roma, Recta (14cm), 5½" K-11-115 1 Tijeras Mayo de Disección, Recta (14cm), 5½"  
K-11-116 1 Tijeras Mayo de Disección, Curva (14cm), 5½" K-12-188 1 Pinza de Kelly, Recta (14cm), 5½"  
K-12-189 1 Pinza de Kelly, Curva (14cm), 5½"  
K-16-287 1 Porta Agujas Mayo Hegar, 6", (15.2cm)  
K-17-318 1 Pinza de Disección, Estriadas Sin Dientes (14cm), 5½" K-18-331 1 Pinza Quirúrgicas, 1x2 con Dientes (14cm), 5½" K-22-481 1 Sondas Acanalada, con Punta de Botón (14cm), 5½" K-23-495 1 Estilete Con Ojo, de (14cm), 5½"

### 040-405-11-S Estuche de Disección con 11 Instrumentos y Terminado

K-02-492-S 1 Mango de Bisturí, #4  
K-11-107S/B-SA 1 Tijeras Quirúrgicas, Aguda/Roma, Recta (14cm), 5½" K-11-115-S 1 Tijeras Mayo de Disección, Recta (14cm), 5½" K-11-116-S 1 Tijeras Mayo de Disección, Curva (14cm), 5½" K-12-188-S 1 Pinza de Kelly, Recta (14cm), 5½"  
K-12-189-S 1 Pinza de Kelly, Curva (14cm), 5½"  
K-16-287-S 1 Porta Agujas Mayo Hegar, (15.2cm), 6"  
K-17-318-S 1 Pinza de Disección, Estriadas Sin Dientes (14cm), 5½" K-18-331-S 1 Pinza Quirúrgicas, 1x2 con Dientes (14cm), 5½" K-22-481-S 1 Sondas Acanalada, con Punta de Botón (14cm), 5½" K-23-495-S 1 Estilete Con Ojo, de (14cm), 5½"

### 040-408-11 Estuche de Disección con 11 Instrumentos

K-02-492 1 Mango de Bisturí, #4  
K-11-107 S/B 1 Tijeras Quirúrgicas, Aguda/Roma, Recta (14cm), 5½"  
K-11-116 1 Tijeras Mayo de Disección, Curva (14cm), 5½"  
K-12-188 1 Pinza de Kelly, Recta (14cm), 5½"  
K-12-189 1 Pinza de Kelly, Curva (14cm), 5½"  
K-16-287 1 Porta Agujas Mayo Hegar, 6", (15.2cm)  
K-17-318 1 Pinza de Disección, Estriadas Sin Dientes (14cm), 5½"  
K-18-331 1 Pinza Quirúrgicas, 1x2 con Dientes (14cm), 5½"  
K-22-481 1 Sondas Acanalada, con Punta de Botón (14cm), 5½"  
K-23-495 1 Estilete Con Ojo, de (14cm), 5½"  
K-26-565 1 Par de Separador de Farabeuf, Juego, de Doble Punta, Grande, 13mmx15.2cm, (15.2cm), 6"

040-409-11-S Estuche de Disección con 11 Instrumentos, Terminado Satinado

K-02-492-S 1 Mango de Bisturí, #4  
 K-11-107S/B-SA 1 Tijeras Quirúrgicas, Aguda/Roma, Recta (14cm), 5½"  
 K-11-116-S 1 Tijeras Mayo de Disección, Curva (14cm), 5½"  
 K-12-188-S 1 Pinza de Kelly, Recta (14cm), 5½"  
 K-12-189-S 1 Pinza de Kelly, Curva (14cm), 5½"  
 K-16-287-S 1 Porta Agujas Mayo Hegar, 6", (15.2cm)  
 K-17-318-S 1 Pinza de Disección, Estriadas Sin Dientes (14cm), 5½" K-18-331-S 1  
 Pinza Quirúrgicas, 1x2 con Dientes (14cm), 5½"  
 K-22-481-S 1 Sondas Acanalada, con Punta de Botón (14cm), 5½"  
 K-23-495-S 1 Estilete Con Ojo, de (14cm), 5½"  
 K-26-565-S 1 Par de Separador de Farabeuf, Juego, de Doble Punta, Grande,  
 13mmx15.2cm, (15.2cm), 6"

040-412-13 Estuche de Disección con 13 Instrumentos

K-02-492 1 Mango de Bisturí, #4  
 K-11-107 S/B 1 Tijeras Quirúrgicas, Aguda/Roma, Recta (14cm), 5½" K-11-  
 108 S/B 1 Tijeras Quirúrgicas, Aguda/Roma, Curva (14cm), 5½" K-11-115 1  
 Tijeras Mayo de Disección, Recta (14cm), 5½"  
 K-11-116 1 Tijeras Mayo de Disección, Curva (14cm), 5½"  
 K-12-182 1 Tijeras Sutura Littauer, para Quitar Puntos (14cm), 5½" K-12-  
 188 1 Pinza de Kelly, Recta (14cm), 5½"  
 K-12-189 1 Pinza de Kelly, Curva (14cm), 5½"  
 K-16-287 1 Porta Agujas Mayo Hegar, (15.2cm), 6"  
 K-17-318 1 Pinza de Disección, Estriadas Sin Dientes (14cm), 5½" K-18-  
 331 1 Pinza Quirúrgicas, 1x2 con Dientes (14cm), 5½" K-22-481 1 Sondas  
 Acanalada, con Punta de Botón (14cm), 5½" K-23-495 1 Estilete Con Ojo,  
 de (14cm), 5½"

040-414-13-S Estuche de Disección con 13 Instrumentos, Terminado Satinado

K-02-492-S 1 Mango de Bisturí, #4  
 K-11-107S/B-SA 1 Tijeras Quirúrgicas, Aguda/Roma, Recta (14cm), 5½" K-  
 11-108S/B-SA 1 Tijeras Quirúrgicas, Aguda/Roma, Curva (14cm), 5½" K-11-  
 115-S 1 Tijeras Mayo de Disección, Recta (14cm), 5½" K-11-116-S 1 Tijeras  
 Mayo de Disección, Curva (14cm), 5½" K-12-182-S 1 Tijeras Sutura Littauer,  
 para Quitar Puntos (14cm), 5½" K-12-188-S 1 Pinza de Kelly, Recta (14cm),  
 5½"  
 K-12-189-S 1 Pinza de Kelly, Curva (14cm), 5½"  
 K-16-287-S 1 Porta Agujas Mayo Hegar, 6", (15.2cm)  
 K-17-318-S 1 Pinza de Disección, Estriadas Sin Dientes (14cm), 5½" K-18-  
 331-S 1 Pinza Quirúrgicas, 1x2 con Dientes (14cm), 5½" K-22-481-S 1  
 Sondas Acanalada, con Punta de Botón (14cm), 5½" K-23-495-S 1 Estilete  
 Con Ojo, de (14cm), 5½"

## KITS PARA PLANEACION FAMILIAR

KIT #1 - Estuche de MINILAPARATOMIA

K-02-490 1 Mango de Bisturí, #4

052-606 2 Hojas de Bisturí #15 (2 Doz.)

K-11-109 B/B 1 Tijeras Quirúrgicas, Roma/Roma, Recta (16.5cm), 6½"

K-11-123 1 Tijeras Metzenbaum, Curva (17.8cm), 7"

K-12-181 4 Pinza de Hartman, Mosquito, Curva (8.9cm), 3½"

K-12-218 2 Pinza de Rochester-Ochsner, con Dientes 1x2, Curva (20.3cm), 8"

K-12-238 2 Instrumental Tonsil Sawtell, Curva (19.1cm), 7½"

K-13-241 4 Pinza de Campo, Backhaus (14cm), 5½"

K-14-256 1 Pinza Porta-Esponjas, Foerster, Boca Estriada, Recta (24.1cm), 9½"

K-16-288 1 Porta Agujas Mayo Hegar, (17.8cm), 7"

K-17-318 1 Pinza de Disección, Estriadas Sin Dientes (14cm), 5½"

K-18-331 1 Pinza Quirúrgicas, 1x2 con Dientes (14cm), 5½"

K-21-393-A 2 Pinza Intestinal de Babcock, Cabeza Pequeña, (24.1cm), 9½"

K-26-566 1 Par de Separador de U.S. Army. Juego, con Doble Punta, (21.6cm), 8½"

K-26-567 2 Retractor Green para LaTiróides (21.6cm), 8½"

K-27-734 1 Espéculo Vaginal de Graves, Mediano (3.5x10cm), 1¾x4"

K-27-870 1 Gancho Vaginal Ramathibodi (24.8cm), 9¾"

K-27-871 1 Elevador Uterino Ramathibodi Curvo (27.9cm), 11"

650-137 2 Agujas para Sutura, Ojo Francés, 1/2 Círculo, Cortantes #6 (2 Doz)

650-230 1 Agujas Keith Abdominal, Recta, Triangular, Ojo Francés #4 (1 Doz)

35-259-C 1 Charola para Instrumental c/marco ovalado (31.1cm x 25.4cm x 1.6cm)  
12¼"x 10" x 5/8"

35-259-P 1 Cubierta P/Charolas Ovaladas (29.2cm x 23.4cm x 10.2cm) 11½" x 9¼" x 4"

35-360 1 Vaso Graduado, Graduado, 2 oz. tamaño (5.4cmx5.1cm), 2½"x2"

Non-Stock 2 Jeringa de Control 10cc

Non-Stock 4 Jeringa Hipodermica 10cc

Non-Stock 2 Agujas Mayo Catgut, 1/2 Círculo, #6 (2 paquetes)

Non-Stock 2 Agujas Hipodermicas, Reusables Graduación de 22 x 1½" (2 paquetes)

Non-Stock 1 Catheter Uretral Femenio, 14 Fr.

**KIT #2 - Estuche de Ginecología**

K-11-152 S/B 1 Tijeras de Sims, Aguda/Roma, Curva (20.3cm), 8"  
 K-12-203-A 2 Pinza de Rochester-Pean, Curva (21.6cm), 8½"  
 K-14-256 1 Pinza de Foerster, Recta (24.1cm), 9½"  
 K-16-288 1 Porta Agujas Mayo-Hegar (17.8cm), 7"  
 K-16-301 2 Porta Agujas Heaney Curva (20.9cm), 8¼"  
 K-17-322 1 Pinza de Disección, Estriadas Sin Dientes (25.4cm), 10"  
 K-19-350 2 Pinza Adson, Sutura Quirúrgicas 1x2 con Dientes (12.1cm), 4¾"  
 K-21-389-A 1 Pinza Intestinal de Thomas-Allis, con Dientes, 6x7 (20.3cm), 8"  
 K-26-620 1 Separador Abdominal Deaver, (2.5x22.9cm), 1x9"  
 K-26-630 1 Separador Abdominal Deaver, (5.1x30.5cm), 2x12" (Un Set)  
 K-26-654 1 Separador Juego de Richardson Eastman, (2 Pzas, Un Set)  
 K-27-771 1 Valva Vaginal de Auvard, con peso de 2lbs. (909gr)  
 K-27-774 1 Pinza Uterina de Braun, de Recta (24.1cm), 9½"  
 K-27-790 1 Histerómetro de Sims Uterino Graduado en cm, maleable (33cm), 13" K-27-810  
 1 Juego de Dilatadores Pratt Uterinos (Juego de 8, Un set)  
 K-27-842 1 Cureta Uterina de Sims, Sz. 3  
 K-27-844 1 Cureta Uterina de Sims, Sz. 5  
 K-27-858 4 Pinza Long de Histerectomía, Longitudinal serrada Curva 1x2 (19.1cm), 7½" 35-  
 259-C 1 Charola para Instrumental c/marco ovalado (31.1cm x 25.4cm x 1.6cm)  
 12¼"x 10" x ⅝"  
 35-259-P 1 Cubierta P/Charolas Ovaladas (29.2cm x 23.4cm x 10.2cm) 11½" x 9¼" x 4" Non-  
 Stock 6 Aguja para Anestesia local, 20G x 6"

**KIT #3 - Estuche para Dispositivo Intrauterino**

K-11-152-S 1 Tijeras de Sims, Aguda/Roma, Curva (20.3cm), 8"  
 K-12-203-A 1 Pinza de Rochester-Pean, Curva (21.6cm), 8½"  
 K-14-256 5 Pinza de Foerster, Recta (24.1cm), 9½"  
 K-27-734 1 Espéculo Vaginal de Graves, Mediano (3.5x10cm), 1⅜x4"  
 K-27-736 1 Espéculo Vaginal de Graves, Grande (3.8x11.4cm), 1½x4½"  
 K-27-774 5 Pinza Uterina de Braun, de Recta (24.1cm), 9½"  
 K-27-784 5 Pinza Bozeman, Uterina Doble Curva (26.7cm), 10½"  
 K-27-790 1 Histerómetro de Sims Uterino Graduado en cm, maleable (33cm), 13"  
 K-27-796 1 Cánula de Novak Uterina para Biopsia 3mm diametro, de 25cm (22.9cm), 9"  
 K-27-872 1 Gancho Removedor del Dispositivo Intrauterino 3mm de diametro maleable  
 (25.4cm), 10"  
 K-27-873 1 Pinza removedor del Dispositivo Intrauterino, 3mm de diametro (20.3cm) 8"  
 35-259-C 1 Charola para Instrumental c/marco ovalado (31.1cm x 25.4cm x 1.6cm)  
 12¼"x 10" x ⅝"  
 35-259-P 1 Cubierta P/Charolas Ovaladas (29.2cm x 23.4cm x 10.2cm) 11½" x 9¼" x 4"  
 35-343 1 Pinza Porta Instrumentos, grande (5.7x17.8cm), 2¼"x7"  
 35-350 5 Yodero, Pequeño Capacidad 14oz, tamaño (12.1cmx6.7cm), 4¾"x2⅝"  
 Non-Stock 5 Guantes Desechables de Cirujano, #7 (5 Pares)  
 Non-Stock 5 Guantes Desechables de Cirujano, #7½ (5 Pares)

KIT #4 - Estuche para Veterinario y Medicina en General

K-02-490 1 Mango de Bisturí, #3  
 052-606 1 Hojas de Bisturí #15 (1 Doz.)  
 K-11-105 S/S 1 Tijeras Quirúrgicas, Aguda/Aguda, Recta (11.4cm), 4½"  
 K-11-109 B/B 1 Tijeras Quirúrgicas, Roma/Roma, Recta (16.54cm), 6½"  
 K-11-115 1 Tijeras Mayo de Disección, Recta (14cm), 5½"  
 K-11-123 1 Tijeras Metzenbaum, Curva (17.8cm), 7"0  
 K-11-136 1 Tijeras Knapp, Curva (10.2cm), 4"  
 K-12-181 4 Pinza de Hartman, Mosquito, Curva (8.9cm), 3½"  
 K-12-188 2 Pinza de Kelly, Recta (14cm), 5½"  
 K-12-198 2 Pinza de Rochester-Pean, Recta (15.9cm), 6¼"  
 K-12-203-A 2 Pinza de Rochester-Pean, Curva (21.6cm), 8½"  
 K-12-218 2 Pinza de Rochester-Ochsner, con Dientes 1x2, Curva (20.3cm), 8"  
 K-13-240 4 Pinza de Campo, Backhaus (8.9cm), 3½"  
 K-14-256 1 Pinza de Foerster, Recta (24.1cm), 9½"  
 K-16-240 1 Porta Agujas Collier (12.7cm), 5"  
 K-16-288 1 Porta Agujas Mayo Hegar (17.8cm), 7"  
 K-17-318 1 Pinza de Disección, Estriadas Sin Dientes (14cm), 5½"  
 K-17-322 1 Pinza de Disección, Estriadas Sin Dientes (25.4cm), 10"  
 K-18-331 1 Pinza Quirúrgicas, 1x2 con Dientes (14cm), 5½"  
 K-19-350 2 Pinza Adson, Sutura Quirúrgicas 1x2 con Dientes (12.1cm), 4¾"  
 K-21-387 2 Pinza Intestinal de Allis, con Dientes, 5x6 (15.2cm), 6"  
 K-21-393 1 Pinza Intestinal de Babcock, (24.1cm) 9½"  
 K-26-566 1 Par de Separador de U.S. Army, Juego, con Doble Punta, (21.6cm), 8½"  
 K-26-567 2 Retractor Green para LaTiróides (21.6cm), 8½"  
 K-26-654 1 Separador Juego de Richardson Eastman, (2 Pzas, Un Set)  
 K-27-734 1 Espéculo Vaginal de Graves, Mediano (3.5x10cm), 1¾x4"  
 K-27-870 1 Gancho Vaginal Ramathibodi (24.8cm), 9¾"  
 K-27-871 1 Elevador Uterino Ramathibodi Curvo (27.9cm), 11"  
 650-137 1 Agujas para Sutura, Ojo Francés, 1/2 Círculo, Cortantes #6 (1 Doz)  
 650-230 2 Agujas Keith Abdominal, Recta, Triangular, Ojo Francés #4 (2 Doz)  
 35-259-C 1 Charola para Instrumental c/marco ovalado (31.1cm x 25.4cm x 1.6cm)  
 12¼"x 10" x 5/8"  
 35-259-P 1 Cubierta P/Charolas Ovaladas (29.2cm x 23.4cm x 10.2cm) 11½" x 9¼" x 4"  
 35-360 1 Vaso Graduado, 2 oz. tamaño (5.4cmx5.1cm), 2⅝"x2"  
 35-382 1 Palangana para Gaza, Capacidad 22 oz. (12.7x6.1cm). 5"x2⅝"  
 Non-Stock 1 Jeringa de Control 5cc  
 Non-Stock 1 Jeringa de Control 10cc  
 Non-Stock 4 Jeringa Hipodermica 5cc  
 Non-Stock 4 Jeringa Hipodermica 10cc  
 Non-Stock 2 Agujas Mayo Catgut, 1/2 Círculo, #6 (2 paquetes)  
 Non-Stock 1 Agujas Hipodermicas, Reusables Graduacion de 22 x ¼" (1 paquete)  
 Non-Stock 2 Agujas Hipodermicas, Reusables Graduacion de 22 x ½" (2 paquetes)  
 Non-Stock 6 Agujas Hipodermicas, Reusables Graduacion de 22 x 1½" (6 paquetes)  
 Non-Stock 1 Cateter Uretral Femenino, 14 Fr.

KIT #5 - Estuche de Vasectomía

K-02-490 1 Mango de Bisturí, #3  
 052-606 1 Hojas de Bisturí #15 (1 Doz.)  
 K-11-105 S/S 1 Tijeras Quirúrgicas, Aguda/Aguda, Recta (11.4cm), 4½"  
 K-11-135 B/B 1 Tijeras Knapp Iris, Roma/Roma, Curva (10.2cm), 4"  
 K-12-181 4 Pinza de Hartman, Mosquito, Curva (8.9cm), 3½"  
 K-12-188 2 Pinza de Kelly, Recta (14cm), 5½"  
 K-13-240 4 Pinza de Campo, Backhaus (8.9cm), 3½"  
 K-14-256 1 Pinza de Forester, Recta (24.1cm), 9½"  
 K-16-240 1 Porta Agujas Collier (12.7cm), 5"  
 K-19-350 1 Pinza Adson, Sutura Quirúrgicas 1x2 con Dientes (12.1cm), 4¾"  
 K-21-387 1 Pinza Intestinal de Allis. con Dientes, 5x6 (15.2cm), 6"  
 650-230 2 Agujas Keith Abdominal, Recta, Triangular, Ojo Francés #4 (2 Doz)  
 35-259-C 1 Charola para Instrumental c/marco ovalado (31.1cm x 25.4cm x 1.6cm)  
 12¼" x 10" x ⅝"  
 35-259-P 1 Cubierta P/Charolas Ovaladas (29.2cm x 23.4cm x 10.2cm) 11½" x 9¼" x 4"  
 Non-Stock 1 Jeringa de Control 5cc  
 Non-Stock 4 Jeringa Hipodermica 5cc  
 Non-Stock 2 Agujas Mayo Catgut, 1/2 Círculo, #6 (2 paquetes)  
 Non-Stock 2 Agujas Hipodermicas, Reusables Graduacion de 22 x 1/2" (2 paquetes)  
 Non-Stock 6 Agujas Hipodermicas, Reusables Graduacion de 22 x 1½" (6 paquetes)  
 Non-Stock 2 Agujas Hipodermicas, Reusables Graduacion de 25 x ¼" (2 paquetes)

KIT #6 - Estuche de Inserción para el Dispositivo Intrauterino

K-11-152 S/B 1 Tijeras de Sims, Aguda/Roma, Curva (20.3cm), 8"  
 K-12-203-A 1 Pinza de Rochester-Pean, Curva (21.6cm), 8½"  
 K-14-256 1 Pinza de Forester, Recta (24.1cm), 9½"  
 K-27-734 1 Espéculo Vaginal de Graves, Mediano (3.5x10cm), 1⅜x4"  
 K-27-736 1 Espéculo Vaginal de Graves, Grande (3.8x11.4cm), 1½x4½"  
 K-27-774 1 Pinza Uterina de Braun, de Recta (24.1cm), 9½"  
 K-27-790 1 Histerómetro de Sims Uterino Graduado en cm, maleable (33cm), 13"  
 35-259-C 1 Charola para Instrumental c/marco ovalado (31.1cm x 25.4cm x 1.6cm)  
 12¼" x 10" x ⅝"  
 35-259-P 1 Cubierta P/Charolas Ovaladas (29.2cm x 23.4cm x 10.2cm) 11½" x 9¼" x 4"  
 35-350 1 Yodero, Pequeño Capacidad 6 oz., tamaño (8.7cm x 5.1cm), 37/16 x 2"  
 Non-Stock 1 Guantes Desechables de Cirujano, #7 (1 Doz.)  
 Non-Stock 1 Guantes Desechables de Cirujano, #7½ (1 Doz.)





## INDEX NUMÉRICO

034-217 .....	124	061-813 .....	115	27-845 .....		35-272 .....	134
034-218 .....	124	061-813-F/O .....	120	100 27-845-10 .....		35-274 .....	134
034-219 .....	124	061-814-A .....	116	100 27-845-6 .....		35-276 .....	134
052-496 .....	127	061-814-B .....	116	101 .....	27-845-7	35-278 .....	134
052-497 .....	127	061-814-F/O .....	120	..... 100 27-845-		35-280 .....	135
052-498 .....	127	061-815 .....	114	8 .....	100 27-	35-282 .....	135
052-499 .....	127	061-815-F/O .....	120	845-9 .....	100	35-284 .....	135
052-500 .....	127	061-816 .....		27-846-7 .....	101	35-286 .....	135
052-501 .....	127	116 061-816-F/O .....		27-847-8 .....	101	35-288 .....	135
052-502 .....	127	120 061-817 .....		27-848-9 .....	101	35-290 .....	135
052-503 .....	127	116 061-817-F/O .....		27-849-10 .....	101	35-298 .....	136
052-504 .....	127	120 061-818 .....		33-1020 .....	111	35-299 .....	136
052-505 .....	127	116 061-818-A .....		33-1022 .....	111	35-300 .....	136
052-506 .....	127	116 061-818-A-F/O .....		33-1029 .....	111	35-301 .....	136
052-507 .....	127	121 061-818-F/O .....		33-1030 .....	111	35-302 .....	136
052-600 .....	127	121 061-819 .....		33-1031 .....	111	35-302-A .....	136
052-600-CS .....	127	117 061-819-F/O .....		33-1034 .....	112	35-303 .....	136
052-602 .....	127	122 061-820 .....		33-1035 .....	112	35-304 .....	136
052-602-CS .....	127	117 061-820-F/O .....		33-1036 .....	112	35-305 .....	136
052-604 .....	127	122 061-825 .....		35-200 .....	132	35-306 .....	136
052-604-CS .....	127	117 061-825-F/O .....		35-202 .....	132	35-307 .....	136
052-606 .....	127	122 061-830 .....		35-204 .....	132	35-308 .....	136
052-606-CS .....	127	117 061-830-F/O .....		35-206 .....	132	35-308-A .....	136
052-608 .....	127	122 061-835 .....		35-208 .....	132	35-309 .....	137
052-608-CS .....	127	117 061-835-F/O .....		35-210 .....	132	35-310 .....	137
052-610 .....	127	122 061-840 .....		35-212 .....	132	35-311 .....	137
052-610-CS .....	127	117 061-840-F/O .....		35-214 .....	132	35-311-A .....	137
052-612 .....	127	122 .....	061-841	35-216 .....	132	35-312 .....	137
052-612-CS .....	127	..... 117		35-218 .....	132	35-313 .....	137
052-614 .....	127	061-841-F/O .....	122	35-220 .....	132	35-314 .....	137
052-614-CS .....	127	061-844 .....	118	35-222 .....	132	35-314-NP .....	138
052-616 .....	127	061-844-F/O .....	123	35-224 .....	132	35-315 .....	137
052-616-CS .....	127	061-845 .....	118	35-226 .....	132	35-315-NP .....	138
052-618 .....	127	061-845-F/O .....	123	35-228 .....	133	35-316 .....	137
052-618-CS .....	127	061-850 .....	118	35-230 .....	133	35-316-NP .....	138
052-620 .....	127	061-850-F/O .....	123	35-232 .....	133	35-317 .....	137
052-620-CS .....	127	061-855 .....	118	35-234 .....	133	35-317-NP .....	138
052-622 .....	127	061-855-F/O .....	123	35-236 .....	133	35-318 .....	137
052-622-CS .....	127	061-860 .....	118	35-238 .....	133	35-318-A .....	137
052-630 .....	129	061-860-F/O .....	123	35-240 .....	133	35-319 .....	137
052-635 .....	129	061-865 .....	118	35-242 .....	133	35-320 .....	138
061-798 .....	114	061-865-F/O .....	123	35-244 .....	133	35-321 .....	138
061-798-F/O .....	119	061-866 .....	118	35-244-A .....	133	35-322 .....	138
061-800 .....	114	061-866-F/O .....	123	35-245 .....	134	35-323 .....	138
061-800-F/O .....	119	061-870 .....	125	35-245-A .....	134	35-324 .....	138
061-805 .....	114	061-875 .....	125	35-246 .....	134	35-325 .....	138
061-805-F/O .....	119	27-838 .....	100	35-248 .....	134	35-326 .....	138
061-807 .....	115	27-838-00 .....	101	35-250 .....	134	35-327 .....	138
061-807-F/O .....	120	27-839 .....	100	35-252 .....	134	35-328 .....	138
061-808 .....	115	27-839-0 .....	101	35-254 .....	134	35-329 .....	138
061-808-F/O .....	120	27-840 .....	100	35-256 .....	134	35-330 .....	139
061-809 .....	115	27-840-1 .....	101	35-258 .....	134	35-333 .....	139
061-809-F/O .....	120	27-841 .....	100	35-259-C .....	134	35-335 .....	139
061-810 .....	114	27-841-2 .....	101	35-259-P .....	134	35-336 .....	139
061-810-F/O .....	119	27-842 .....	100	35-260 .....	134	35-337 .....	139
061-811 .....	115	27-842-3 .....	101	35-262 .....	134	35-337-F .....	139
061-811-F/O .....	120	27-843 .....		35-264 .....	134	35-338 .....	140
061-812 .....	116	100 27-843-4 .....		35-266 .....	134	35-339 .....	140
061-812-F/O .....	120	101 .....	27-844	35-268 .....	134	35-340 .....	140
		..... 100 27-		35-270 .....	134		
		844-5 .....	101				



## INDEX NUMÉRICO

35-341 .....	140	35-429 .....	146	650-153-S .....	130	DNS-24 .....	128
35-342 .....	140	35-430 .....	146	650-155-S .....	130	DNS-60 .....	128
35-343 .....	140	35-431 .....	146	650-157-S .....		DNS-70 .....	128
35-344 .....	140	35-432 .....	146	130 650-201-S .....		GS-55-670 .....	84
35-345 .....	140	35-433 .....	146	131 650-202-S .....		GS-55-680 .....	78
35-347 .....	141	35-434 .....	146	131 650-203-S .....		GS-55-682 .....	78
35-348 .....	141	35-435 .....	146	131 650-204-S .....		GS-55-684 .....	78
35-349 .....	141	35-436 .....	146	131 650-205-S .....		GS-55-686 .....	78
35-350 .....	141	35-437 .....	146	131 650-206-S .....		GS-55-689 .....	85
35-355 .....	141	35-450 .....	147	131 650-207-S .....		GS-55-690 .....	85
35-357 .....	142	35-452 .....	147	131 650-208-S .....		GS-55-692 .....	85
35-358 .....	142	35-454 .....	147	131 650-209-S .....		GS-55-694 .....	85
35-360 .....	142	35-456 .....	147	131 650-210-S .....		GS-55-702 .....	85
35-362 .....	142	35-458 .....	147	S .....	131 650-211-	GS-65-688 .....	78
35-365 .....	142	35-460 .....	147	212-S .....	131	K-02-442 .....	3
35-368 .....	142	35-462 .....	147	650-213-S .....	131	K-02-445 .....	3
35-369 .....	143	35-464 .....	147	650-214-S .....	131	K-02-446 .....	3
35-370 .....	143	35-466 .....	147	650-215-S .....	131	K-02-447 .....	3
35-370-A .....	143	35-468 .....	147	650-216-S .....	131	K-02-448 .....	4
35-370-B .....	143	35-470 .....	147	650-224-S .....	131	K-02-451 .....	4
35-370-C .....	143	35-472 .....	147	650-226-S .....	131	K-02-452 .....	4
35-370-D .....	143	35-474 .....	147	650-228-S .....	131	K-02-460 .....	1
35-370-E .....	143	35-476 .....	147	650-230-S .....	131	K-02-461 .....	1
35-371 .....	143	35-478 .....	148	650-232-S .....	131	K-02-463 .....	1
35-372 .....	143	35-480 .....	148	650-233-S .....	131	K-02-463-S .....	1
35-375 .....	144	35-482 .....	148	650-234-S .....	131	K-02-467 .....	2
35-376 .....	144	35-484 .....	148	706-101 .....	110	K-02-468 .....	2
35-377 .....	144	35-486 .....	148	706-119 .....	110	K-02-469 .....	2
35-378 .....	144	35-506 .....	145	706-127 .....	110	K-02-470 .....	2
35-381 .....	144	35-506-A .....	145	767-004 .....	60	K-02-471 .....	2
35-382 .....	144	35-506-B .....	145	767-005 .....	60	K-02-472 .....	2
35-383 .....	144	35-507 .....	145	965-690 .....	126	K-02-490 .....	8
35-384 .....	144	35-508 .....	145	965-692 .....	126	K-02-490-SC .....	8
35-385 .....	144	35-509 .....	145	965-694 .....	126	K-02-491 .....	8
35-386 .....	144	35-510 .....	145	965-695 .....	126	K-02-492 .....	8
35-390 .....	144	35-511 .....	145	965-697 .....	126	K-02-492-SC .....	8
35-391 .....	144	35-700 .....	148	965-699 .....	126	K-02-493 .....	8
35-392 .....	144	35-702 .....	148	965-700 .....	126	K-02-494 .....	8
35-393 .....	144	35-704 .....	148	965-702 .....	126	K-11-107-B/B .....	9
35-394 .....	144	35-706 .....		965-704 .....	126	K-11-107-S/B .....	9
35-395 .....	144	148		965-706 .....	126	K-11-107-S/S .....	9
35-396 .....	144	35-712 .....	149	965-708 .....	126	K-11-108-B/B .....	10
35-406 .....	145	35-714 .....	149	965-710 .....	126	K-11-108-S/B .....	10
35-406-A .....	145	35-720 .....	149	965-712 .....	126	K-11-108-S/S .....	10
35-407 .....	145	35-722 .....	149	965-713 .....	126	K-11-109-B/B .....	9
35-407-A .....	145	35-723 .....	149	965-714 .....	126	K-11-109-S/B .....	9
35-408 .....	145	650-125-S .....	130	965-715 .....	126	K-11-110-S/B .....	10
35-409 .....	145	650-127-S .....	130	965-716 .....	126	K-11-115 .....	11
35-410 .....	145	650-129-S .....	130	965-718 .....	126	K-11-116 .....	11
35-411 .....	145	650-131-S .....	130	965-720 .....	126	K-11-117 .....	11
35-412 .....	145	650-133-S .....	130	965-722 .....	126	K-11-118 .....	11
35-414 .....	145	650-135-S .....	130	965-724 .....	126	K-11-119-A .....	11
35-416 .....	145	650-137-S .....	130	DNS-10 .....		K-11-119-B .....	11
35-418 .....	145	650-139-S .....	130	128 DNS-11 .....		K-11-119-D .....	12
35-420 .....	145	650-141-S .....	130	12 DNS-12 .....	128	K-11-119-E .....	12
35-425 .....	146	650-143-S .....		DNS-15 .....	128	K-11-120 .....	12
35-426 .....	146	130 650-145-S .....		DNS-20 .....	128	K-11-120-A .....	13
35-427 .....	146	S .....	130 650-147-	DNS-21 .....	128	K-11-121 .....	12
35-428 .....	146	149-S .....	130	DNS-22 .....	128	K-11-121-B .....	13
		650-151-S .....	130	DNS-23 .....	128		



## INDEX NUMÉRICO

K-11-122 .....	13	K-12-203 .....	29	K-16-287 .....	40	K-18-335 .....	46
K-11-123 .....	13	K-12-203-A .....	29	K-16-288 .....	40	K-18-349 .....	46
K-11-124 .....	14	K-12-204 .....	29	K-16-290 .....	40	K-18-349-A .....	46
K-11-125 .....	14	K-12-204-A .....	29	K-16-290-B .....	40	K-18-350 .....	47
K-11-126 .....	14	K-12-205 .....	29	K-16-291 .....	40	K-18-352 .....	47
K-11-127 .....	14	K-12-205-A .....	29	K-16-292 .....	40	K-19-325 .....	47
K-11-127-A .....	14	K-12-206 .....	29	K-16-292-A .....	40	K-19-330 .....	47
K-11-127-B .....	14	K-12-207 .....	29	K-16-293 .....	40	K-19-335 .....	47
K-11-128-A .....	14	K-12-211 .....	30	K-16-293-A .....	40	K-19-340 .....	47
K-11-128-B .....	14	K-12-212 .....	30	K-16-294 .....	40	K-19-344 .....	48
K-11-129-A .....	14	K-12-213 .....	30	K-16-296 .....	41	K-19-345 .....	48
K-11-129-B .....	14	K-12-214 .....	30	K-16-297 .....	41	K-19-346 .....	48
K-11-130 .....	15	K-12-215 .....	30	K-16-298 .....	41	K-19-347 .....	48
K-11-131 .....	15	K-12-216 .....	30	K-16-299 .....	41	K-19-348 .....	48
K-11-138 .....	15	K-12-217 .....	30	K-16-300 .....	41	K-19-349 .....	48
K-11-139 .....	15	K-12-217-A .....	30	K-16-301 .....	41	K-19-350 .....	48
K-11-142 .....	15	K-12-218 .....	30	K-16-302 .....	42	K-19-351-S .....	47
K-11-147 .....	16	K-12-218-A .....	30	K-16-303 .....	42	K-21-386 .....	50
K-11-147-A .....	16	K-12-218-B .....	30	K-16-303-A .....	42	K-21-387 .....	50
K-11-148 .....	16	K-12-218-C .....	30	K-16-306 .....	43	K-21-388 .....	50
K-11-153 .....	17	K-12-218-D .....	30	K-16-308 .....	43	K-21-388-B .....	50
K-11-154 .....	17	K-12-218-E .....	30	K-16-335 .....	43	K-21-389 .....	50
K-11-155 .....	17	K-12-229-S .....	31	K-16-339 .....	43	K-21-389-A .....	50
K-11-155-A .....	17	K-12-230 .....	31	K-16-800 .....	23	K-21-391 .....	50
K-11-155-B .....	17	K-12-231 .....	31	K-16-802 .....	23	K-21-392 .....	50
K-11-155-C .....	17	K-12-232 .....	31	K-16-826 .....	24	K-21-393 .....	50
K-11-157 .....	18	K-12-232-A .....	31	K-16-830 .....	24	K-21-394 .....	51
K-11-158 .....	18	K-12-235 .....	54	K-16-835 .....	25	K-21-394-A .....	51
K-11-159 .....	18	K-12-236 .....	54	K-16-838 .....	25	K-21-395 .....	51
K-11-176 .....	19	K-12-237 .....	54	K-16-840 .....	25	K-21-395-A .....	51
K-11-177 .....	19	K-12-238 .....	54	K-16-842 .....	25	K-21-395-B .....	51
K-11-178 .....	20	K-13-240 .....	34	K-16-842-A .....	25	K-21-397 .....	52
K-11-180 .....	20	K-13-240-A .....	34	K-16-842-B .....	25	K-21-398 .....	52
K-11-181 .....	20	K-13-240-B .....	34	K-16-843 .....	25	K-21-399 .....	52
K-11-182 .....	20	K-13-241 .....	34	K-16-844 .....	25	K-22-475 .....	53
K-11-186-A .....	21	K-13-241-B .....	34	K-16-845 .....	25	K-22-476 .....	53
K-11-186-B .....	21	K-13-242 .....	34	K-16-846 .....	25	K-22-477 .....	53
K-11-188 .....	21	K-13-243 .....	34	K-16-851 .....	26	K-22-478 .....	53
K-12-180 .....	27	K-13-244 .....	35	K-16-852 .....	26	K-22-478-A .....	53
K-12-181 .....	27	K-13-246 .....	35	K-16-854 .....	26	K-22-478-B .....	53
K-12-182 .....	27	K-13-248 .....	35	K-16-856 .....	26	K-22-479 .....	53
K-12-183 .....	27	K-14-252 .....	36	K-16-858 .....	26	K-22-480 .....	53
K-12-187-D .....	27	K-14-253 .....	36	K-16-860 .....	26	K-22-481 .....	53
K-12-188 .....	28	K-14-254 .....	36	K-16-870 .....	26	K-22-482 .....	53
K-12-189 .....	28	K-14-255 .....	36	K-17-316 .....	46	K-22-482-A .....	53
K-12-190 .....	28	K-14-256 .....	36	K-17-317 .....	46	K-22-482-B .....	53
K-12-191 .....	28	K-14-256-A .....	37	K-17-318 .....	46	K-23-488 .....	53
K-12-192 .....	28	K-14-256-B .....	37	K-17-319 .....	46	K-23-489 .....	53
K-12-193 .....	28	K-14-256-C .....	37	K-17-321 .....	46	K-23-490 .....	53
K-12-194 .....	28	K-14-257 .....	36	K-17-321-A .....	46	K-23-491 .....	53
K-12-195 .....	28	K-14-258 .....	37	K-17-322 .....	46	K-23-491-A .....	53
K-12-196 .....	29	K-14-260 .....	92	K-17-323 .....	46	K-23-492 .....	53
K-12-197 .....	29	K-14-265 .....	38	K-18-329 .....	46	K-23-493 .....	53
K-12-198 .....	29	K-14-270 .....	38	K-18-330 .....	46	K-23-494 .....	53
K-12-199 .....	29	K-16-254 .....	39	K-18-331 .....	46	K-23-495 .....	53
K-12-200 .....	29	K-16-283 .....	39	K-18-332 .....	46	K-23-496 .....	53
K-12-201 .....	29	K-16-284 .....	39	K-18-332-A .....	46	K-23-497 .....	53
K-12-202 .....	29	K-16-285 .....	39	K-18-333 .....	46	K-23-498 .....	53
K-12-202-A .....	29	K-16-286 .....	40	K-18-334 .....	46	K-23-499 .....	53



## INDEX NUMÉRICO

K-24-663 .....	49	K-26-561 .....	64	K-26-658 .....	73	K-27-736 .....	86
K-24-664 .....	49	K-26-563 .....	64	K-26-659 .....	73	K-27-739 .....	86
K-24-665 .....	49	K-26-563-B .....	64	K-26-660 .....	73	K-27-739-A .....	86
K-24-666 .....	49	K-26-564 .....	65	K-26-666 .....	73	K-27-749 .....	87
K-24-667 .....	49	K-26-564-A .....	65	K-26-667 .....	73	K-27-750 .....	87
K-24-668 .....	49	K-26-565 .....	65	K-26-668 .....	73	K-27-751 .....	87
K-25-693 .....	55	K-26-566 .....	65	K-26-700 .....	74	K-27-752 .....	87
K-25-695 .....	55	K-26-569 .....	66	K-26-701 .....	74	K-27-760 .....	88
K-25-696 .....	55	K-26-570 .....	66	K-26-702 .....	74	K-27-760-A .....	88
K-25-697 .....	55	K-26-571 .....	66	K-26-703 .....	74	K-27-761 .....	88
K-25-698 .....	55	K-26-572 .....	66	K-26-703-A .....	75	K-27-762 .....	88
K-25-699 .....	55	K-26-572-A .....	66	K-26-703-B .....	75	K-27-771 .....	88
K-25-700 .....	55	K-26-573 .....	66	K-26-703-C .....	75	K-27-771-A .....	88
K-25-701 .....	55	K-26-574 .....	66	K-26-704 .....	75	K-27-771-B .....	88
K-25-705 .....	55	K-26-575 .....	66	K-26-705 .....	76	K-27-771-C .....	88
K-25-706 .....	55	K-26-575-A .....	66	K-26-707 .....	76	K-27-772 .....	89
K-25-707 .....	55	K-26-576 .....	66	K-26-708 .....	76	K-27-772-A .....	89
K-25-710 .....	57	K-26-576-A .....	66	K-26-709 .....	76	K-27-772-B .....	89
K-25-711 .....	57	K-26-576-B .....	66	K-26-710 .....	76	K-27-772-C .....	89
K-25-712 .....	57	K-26-577 .....	67	K-26-711 .....	77	K-27-774 .....	90
K-25-713 .....	57	K-26-577-C .....	67	K-26-713 .....	77	K-27-775-A .....	38
K-25-730 .....	58	K-26-577-D .....	67	K-26-715 .....	77	K-27-775-B .....	38
K-25-731 .....	58	K-26-578 .....	67	K-26-716 .....	77	K-27-776 .....	90
K-25-732 .....	58	K-26-578-A .....	68	K-26-717 .....	77	K-27-781 .....	32
K-25-733 .....	58	K-26-578-B .....	68	K-26-718 .....	77	K-27-781-A .....	32
K-25-734 .....	58	K-26-578-C .....	68	K-26-720 .....	77	K-27-782-A .....	33
K-25-735 .....	58	K-26-578-D .....	68	K-26-721 .....	77	K-27-782-B .....	91
K-25-736 .....	58	68 K-26-578-E .....	68	K-26-722 .....	77	K-27-783 .....	91
K-25-737 .....	59	K-26-578-F .....	68	K-26-723 .....	77	K-27-784 .....	91
K-25-738 .....	59	K-26-578-G .....	68	K-26-732 .....	95	K-27-785-E .....	97
K-25-738-A .....	59	K-26-578-H .....	68	K-26-735 .....	32	K-27-785-F .....	97
K-25-738-B .....	59	K-26-581 .....	69	K-26-736 .....	32	K-27-790 .....	92
K-25-738-C .....	59	K-26-581-A .....	69	K-26-737 .....	32	K-27-794 .....	93
K-25-739 .....	56	K-26-582 .....	69	K-26-740 .....	79	K-27-795 .....	93
K-25-740 .....	56	K-26-583 .....	69	K-26-750 .....	79	K-27-796 .....	93
K-25-741 .....	56	K-26-584 .....	69	K-26-751 .....	80	K-27-797 .....	93
K-25-744 .....	61	K-26-585 .....	69	K-26-752 .....	80	K-27-800 .....	98
K-25-745 .....	61	K-26-586 .....	70	K-26-755 .....	80	K-27-810 .....	99
K-25-746 .....	61	K-26-587 .....	70	K-26-760 .....	81	K-27-855 .....	102
K-25-747 .....	61	K-26-610 .....	70	K-26-775 .....	82	K-27-856 .....	102
K-25-748 .....	61	K-26-611 .....	70	K-26-776 .....	82	K-27-857 .....	102
K-25-780 .....	63	K-26-612 .....	70	K-26-780 .....	82	K-27-857-A .....	33
K-25-781 .....	63	K-26-613 .....	70	K-26-781 .....	82	K-27-857-B .....	33
K-25-782 .....	63	K-26-614 .....	70	K-26-782 .....	82	K-27-858 .....	103
K-25-783 .....	63	K-26-615 .....	70	K-26-783 .....	83	K-27-858-A .....	103
K-25-784 .....	63	K-26-616 .....	70	K-26-784 .....	83	K-27-858-B .....	103
K-25-785 .....	63	K-26-617 .....	70	K-26-785 .....	83	K-27-867 .....	96
K-25-786 .....	63	K-26-618 .....	70	K-27-700 .....	94	K-27-868 .....	96
K-25-790 .....	63	K-26-620 .....	71	K-27-702 .....	94	K-27-869 .....	96
K-25-791 .....	63	K-26-623 .....	72	K-27-705 .....	94	K-27-880 .....	96
K-25-792 .....	63	K-26-625 .....	72	K-27-706 .....	94	K-27-882 .....	96
K-25-793 .....	63	K-26-628 .....	72	K-27-707 .....	94	K-27-884 .....	96
K-25-794 .....	63	K-26-630 .....	72	K-27-709 .....	94	K-27-888 .....	97
K-25-795 .....	63	K-26-635 .....	72	K-27-710 .....	94	K-27-930 .....	100
K-25-796 .....	63	K-26-640 .....	71	K-27-711 .....	94	K-28-820 .....	105
K-25-840 .....	62	K-26-643 .....	71	K-27-712 .....	95	K-28-821 .....	105
K-25-841 .....	62	K-26-645 .....	71	K-27-730 .....	86	K-28-822 .....	105
K-25-842 .....	62	K-26-654 .....	73	K-27-732 .....	86	K-28-824 .....	105
K-25-843 .....	62	K-26-657 .....	73	K-27-734 .....	86	K-28-825 .....	105



## INDEX NUMÉRICO

K-28-827 .....	105	MDNS-11 .....	129
K-28-829 .....	105	MDNS-15 .....	129
K-28-830 .....	106	MDNS-60 .....	129
K-28-831 .....	106	MDNS-70 .....	129
K-28-833 .....	106	PA-1948-10 .....	128
K-28-835 .....	106	PA-1948-11 .....	128
K-28-837 .....	107	PA-1948-12 .....	128
K-28-839 .....	107	PA-1948-15 .....	128
K-28-843 .....	107	PA-1948-20 .....	128
K-28-850 .....	104	PA-1948-21 .....	128
K-28-851 .....	104	PA-1948-22 .....	128
K-28-852 .....	104	PA-1948-23 .....	128
K-28-853 .....	104	PA-1948-24 .....	128
K-28-860-V .....	108	SCNS-1948 .....	129
K-28-863-V .....	108	SCNS-1950 .....	129
K-29-858 .....	52	SCNS-1960 .....	129
K-29-860 .....	109	SCNS-1965 .....	129
K-29-861 .....	109	SCNS-1970 .....	129
K-29-862 .....	109		
K-29-863 .....	109		
K-29-864 .....	109		
K-29-865 .....	109		
K-30-887 .....	22		
K-30-888 .....	22		
K-30-904 .....	110		
K-30-904-A .....	110		
K-30-905 .....	110		
K-32-573 .....	6		
K-32-575 .....	6		
K-32-580 .....	6		
K-32-582 .....	7		
K-32-583 .....	7		
K-32-584 .....	7		
K-32-585 .....	7		
K-32-590 .....	5		
K-32-592 .....	7		
K-32-593 .....	5		
K-32-600 .....	5		
K-32-605 .....	5		
K-32-607 .....	5		
K-33-1032 .....	113		
K-33-1033 .....	113		
K-35-515 .....	44		
K-35-520 .....	44		
K-35-525 .....	44		
K-35-530 .....	44		
K-35-535 .....	45		
K-35-536 .....	45		
K-35-537 .....	45		
K-35-537-A .....	45		
K-35-538 .....	45		
K-35-542 .....	45		
K-35-545 .....	45		
K-35-550 .....	45		
K-35-550-A .....	45		
K-35-551 .....	45		
K-35-552 .....	45		
K-35-553 .....	45		
MDNS-10 .....	129		



## INDEX ALFABÉTICO

### A

Abre Boca .....	3, 6, 7
ADSON Pinza de Disección .....	48
ADSON Pinza Quirúrgicas .....	48
ADSON Separador con Garras .....	67
Agujas para Sutura .....	130, 131
ALLEN Pinza Intestinal .....	52
ALLIS Pinza Intestinal con Dientes .....	50
ALLIS-ADAIR Pinza Intestinal .....	52
ALM Separador Autoretenido .....	67
ANDREWS Depresor de Lengua .....	5
AUVARD Valva Vaginal .....	88

### B

BABCOCK Pinza Intestinal .....	50
BABINSKI Martillo de Percusión .....	2
Bacinillas Patos-Orinales .....	139
BACKHAUS Pinza de Campo .....	34
BAKES Set de dilatadores .....	81
BALFOUR Separador con Valvas Fenestradas .....	74, 76
BALFOUR Valva Central Estandar .....	75
BALLENGER Pinza Porta-Esponjas .....	36
Bandejas para Cateters con Cubierta Plana y Manija .....	137
Bandejas Profundas con Perforación .....	137
Bandejas Profundas sin Perforación .....	138
BAUER Pinza Porta-Esponjas .....	37
BAUMGARTNER Porta Agujas de TC .....	39, 44
BEACHAM Amniotomo .....	91
BECKMAN Separador con Dientes .....	68
BILLEAU Asas para Oído .....	55
BLAKES Pinza para Piedras Biliares .....	82
BODENHAMMER Especulo .....	109
Bombillas de Halogeno para Laringoscopio de F/O .....	119
Bombillas para Laringoscopios .....	114
BONNEY Pinzas Quirúrgicas .....	46
BOYNTON Porta Agujas .....	43
BOZEMAN Pinza Uterina .....	91
BRAUN Pinza Uterina .....	90
BRAUN Tijeras de Episiotomía .....	16
BROWN Porta Agujas .....	42
BROWN-ADSON Pinza Quirúrgicas .....	47
BRUNS (LANGENBECK) Sierra Metacarpiano .....	111
BRUNS Tijeras Para Emplasto .....	22
BUCK Cureta para Oído .....	55
BUCK Martillo Neurológico .....	1

### C

Cajas para Esterilizar con Tapa sin Asa .....	145
Cajas para Esterilizar con Tapa y Asa .....	145
Canulas de Succión .....	4, 63
Canulas Para Biopsia .....	93
Canulas Uterinas .....	93
Canulas, Tubos de Aspiración .....	63
Carros de Servicio con Tres Niveles .....	149
CASTROVIEJO Porta Agujas .....	43
CASTROVIEJO Tijeras para Operaciones .....	17
Cepillo de Cánula con Cerdas .....	126
Cepillo de Tubo de Traquea .....	126
Cepillos de Limpieza para Cirujano .....	126
Cepillos Surgeons .....	126
Charolas con Tapas para Instrumental .....	134
Charolas de Alambre para Esterilización .....	138
Charolas para Cateters con Cubiertas Ovaladas .....	137
Charolas para Medicamento para Camas .....	135
Charolas Riñoneras .....	140
CHARRIERE Sierra de Hueso .....	111
CHERON Pinza Uterina .....	37, 92
COLLIN (BUXTON) Pinza Uterina .....	92
COLLIN (JUDD-DeMARTEL) Pinza Vesicular .....	79
COLLIN Especulo Vaginal .....	88
COLLIN Pinza Instestinal .....	50, 51
COLLINS Pinza abre boca .....	3
COLUMBIA Retractor Labial .....	5
Comodos .....	139
Contenedores con Tapa .....	132
Contenedores con Tapa y Manija .....	132
Cortador de Anillos para dedos .....	2
Cortador de puntada .....	129
CRILE Pinza Hemostática .....	28
CRILE-WOOD (DEBAKEY) Porta Agujas .....	40
CRILE-WOOD (DEBAKEY) Porta Agujas de TC .....	45
CRILE-WOOD Porta Agujas .....	40
CRILE-WOOD Porta Agujas de TC .....	45
CROWN AND COLLAR Tijeras para Vendaje .....	21
Cubetas con Tapas para Solución .....	133
Cubilete Agitador .....	133
Curetas Para Ginecología Y Dilatadores .....	98-101

### D

DANDY Pinza Hemostática .....	27
DARTIGUES Pinza Uterina .....	97
DEAVER Separador Abdominal .....	71, 72
DeLEE HILLIS Stetoscopio Obstetrico .....	124





## INDEX ALFABÉTICO

DeLEE Pinza Obstetrica .....	105
DeLEE Retractor Universal .....	97
Depresor de Lengua .....	5
Diapasón Neurológico sin Sordina .....	58
Diapasón y Martillo Neurológico Buck .....	59
Diapasones Neurológicos De Aluminio ....	58, 59, 60
Diapasones Neurológicos con Sordina .....	58
Diapasones Neurológicos, Estuche .....	60
DOYEN Pinza Intestinal .....	51
DOYEN Separador Abdominal .....	95, 77
DOYEN Separador Valva Vaginal .....	73
DOYEN-JANSEN Abre-boca .....	6
DUVAL-COLLIN Pinza Intestinal .....	51

### E

EASTMAN RetractorVaginal .....	96
ELLIOT Pinza Obstetrica .....	105
Equipo De Otoscopia .....	124, 125
ESMARCH Tijeras Para Emplasto .....	22
Especulos Nasales .....	61, 62
Especulos Vaginales .....	86, 87, 88, 94
Estilete Bolivar .....	53
Estilete con Ojo .....	53
Estuches para Esterilizar Agua .....	142

### F

FARABEUF Separador .....	65
FERGUSON Cucharilla para piedras Biliares .....	82
FERRIS-SMITH Pinza Quirúrgicas .....	47
FINE Pinza de Disección .....	49
FINOCHIETTO Porta Agujas .....	42
FINOCHIETTO Separador .....	78, 84, 85
FINOCHIETTO-DeBAKEY Separador .....	78, 84
FLETCHER Pinza Porta-Esponjas .....	38
FOERSTER Pinza Porta-Esponjas .....	36
FRAZIER-FERGUSON Cánula de Succión .....	63

### G

GELPI Separador .....	69
GIGLI Sierra tipo Estandar .....	110
GIGLI-STRULLY Mango para Sierra de alambre .....	110
GILLIES Porta Agujas .....	43
GOELET Separador .....	64
GOSSETT Separador .....	76
GRAVES Especulo Vaginal .....	86
GRAY Pinza Cistica .....	80
GREEN Pinza Cistica .....	79

GUTTMAN Especulo Vaginal .....	86
--------------------------------	----

### H

HALSEY Porta Agujas .....	39
HALSEY Porta Agujas de TC .....	44
HALSTEAD Pinza Hemostática .....	27
HARTMAN Pinza Hemostática .....	27
HARTMAN Pinza Nasal y Oído .....	57
HEANEY Pinza para Histerectomía .....	102
HEANEY Porta Agujas .....	41
HEANEY-BALLENTINE Pinza Hemostática .....	33
HEANEY-BALLENTINE Pinza para Histerectomía .....	102
HEANEY-SIMON Separador Vaginal .....	95
HEGAR Juego de Dilatadores Uterinos .....	98
HIRSCHMAN Anoscopio .....	109
HOFF Pinza de Campo .....	35
Hojas de Bisturí .....	127-129
Hojas de Bisturi de pulgar .....	129
Hojas de Bisturi Desechables .....	128
Hojas de Bisturi Esteriles .....	127
Hojas para Laringoscopios .....	117, 118, 122, 123
HUMBY Cuchillo Dermatológico .....	129
HUMBY Hojas Dermatológicas .....	129

### I

Instrumental Cardiovascular Atraumático .....	83-85
Instrumental Nasal Y Para Oído .....	55-57
Instrumental Para Ginecología .....	86-89, 94-97
Instrumental Para Vasectomía Sin Bisturí .....	108
Instrumental Rectal .....	109
Instrumental Tonsila .....	54
Instrumental Tonsila (Amígdalas) Y Oral .....	6, 7
Instrumentos Para Anestesia .....	3, 5
Instrumentos Para Cálculos Biliares .....	79-82
Instrumentos Para Diagnóstico, Martillos .....	1, 2
Instrumentos Post Mortorios Y Ortopédicos .....	113
IRIS Pinza de Disección .....	49
IRIS Tijeras para Operaciones .....	15
IRIS Tijeras Quirúrgicas de TC .....	24
Irrigadores con Manija .....	148

### J

Jaboneras Esterilizadoras .....	141
JACKSON Retractor Vaginal .....	96
JACOBS (MUSEUX) Pinza Uterina .....	90
JACOBS Pinza Hemostática .....	32
JACOBS Pinza Uterina .....	90
JANSEN Pinza para el Oído .....	55





## INDEX ALFABÉTICO

JANSEN-GRUENWALD Pinza para el Oído .....	55
Jarras de Lados Rectos .....	135
Jarras Graduadas .....	142
JENNINGS Abre-boca .....	7
Jeringa para Oído .....	56
JONES Pinza de Campo .....	35
Juegos de Charolas para Esterilización .....	134

### K

KEITH Aguja Abdominal .....	131
KELLY Pinza Hemostática .....	28
KELLY Pinza para Placenta .....	107
KELLY-RANKIN Pinza Hemostática .....	28
KIELAND Pinza Obstetrica .....	106
KIELAND-LUIKART Pinza Obstetrica .....	106
KILLIAN Espéculo Nasal .....	62
KOCHER Pinza Hemostática .....	30
KOGAN Especulo Endocervical .....	89
KRISTELLER Especulo Vaginal .....	94

### L

LAHEY Pinza Hemostática .....	33
LAHEY Pinza Hemostática de Disección .....	32
LAHEY Pinza Vesicular .....	79
Laringoscopios .....	114-123
LISTER Tijeras para Vendajes .....	18
LITTAUER Tijeras para Vendaje .....	20
LONG Pinza de Histerectomía .....	103
LORNA Pinza de Campo .....	34
LUCAE Pinza para el Oído .....	55
LUIKART Pinza Obstetrica .....	106

### M

MACINTOSH Estuche de Laringoscopio .....	115
MACINTOSH Estuche de Laringoscopio de F/O .....	120
MACINTOSH Hojas para Laringoscopios .....	117
MACINTOSH Hojas para Laringoscopios de F/O .....	122
MAGILL Pinzas .....	3
Mango para Laringoscopio .....	114
Mango para Laringoscopio de F/O .....	119
Mangos de Bisturí .....	8
Mangos para Sierra .....	110
Martillo Neurológico con Molinete .....	59
Martillo Neurológico Telescopico .....	1
Martillos de Acero .....	113
Martillos Post Mortorios .....	113
MASSON Porta Agujas .....	42

MATHIEU Porta Agujas .....	41
MAYO Charolas (Bandejas) con Perforación ....	136
MAYO Charolas (Bandejas) sin Perforación ....	136
MAYO Separador Abdominal .....	77
MAYO Tijeras de Disección .....	11
MAYO Tijeras de Disección TC .....	26
MAYO Tijerasde Disección .....	11
MAYO-HARRINGTON Tijeras de Disección .....	12
MAYO-HEGAR Porta Agujas de TC .....	45
MAYO-HEGAR (MASSON) Porta Agujas de TC .....	45
MAYO-HEGAR Porta Agujas .....	40
MAYOTijeras de Disección .....	11
Mazos .....	112
MCIVOR Abre-boca, Set .....	7
MCLEAN-LUIKART Pinza Obstetrica .....	107
METZENBAUM Tijeras para Mastectomía .....	14
METZENBAUM Tijeras para Operaciones .....	12, 13, 14
METZENBAUM Tijeras Quirurgicas de TC .....	25
MILLER Estuche de Laringoscopio .....	116
MILLER Estuche de Laringoscopio de F/O .....	120
MILLER Hojas para Laringoscopios .....	118
MILLER Hojas para Laringoscopios .....	123
MILLER-MACINTOSH Estuche de Laringoscopio .....	116
MILLER-MACINTOSH Estuche de Laringoscopio de F/O .....	121
MIXTER Pinza Hemostática .....	31
MOYNIHAN Pinza Vesicular .....	80

### N

NOVAK Cánula Uterina .....	93
----------------------------	----

### O

OLSEN-HEGAR Porta Agujas .....	41
O'SULLIVAN-O'CONNOR Separador Abdominal .....	76
Otoscopio Económico con lentes móviles .....	125

### P

Palanganas Lavamanos .....	141
Palanganas para Gaza .....	144
Palanganas para Mezclar .....	147
Palanganas para Solución .....	144
Palanganas Tipo "J" .....	147
PARKER Separador .....	64
PEDERSON Especulo Vaginal .....	87
PHANUEF Pinza Uterina con Dientes .....	103



## INDEX ALFABÉTICO

PINARD Stetoscopio .....	124
Pinza Cística .....	79
Pinzas Abre Boca .....	3
Pinzas de Anillo Pequeño de Huevo .....	38
Pinzas de Campo .....	34, 35
Pinzas de Disección y Quirúrgicas .....	32, 46, 47, 48
Pinzas de Traslado .....	143
Pinzas Hemostáticas .....	27-33
Pinzas Intestinales .....	50-52
Pinzas Obstétricas .....	105-107
Pinzas Para Cálculos Biliares .....	104
Pinzas para Cuerpos Extraños .....	57
Pinzas para el Oído .....	55
Pinzas para Histerectomía .....	102-103
Pinzas para la Vesícula .....	79, 80
Pinzas para Piedras Biliares .....	82
Pinzas para Vasectomía .....	108
Pinzas para Vena Cava .....	83
Pinzas Porta Esponjas .....	36, 37
Pinzas Quirúrgicas con Dientes .....	46
Pinzas Torácica .....	84
Pinzas Uterinas .....	90, 91, 92
PIPER Pinza Obstetrica .....	107
Plato para Placenta con Cubierta .....	149
POOL Cánula de Succión .....	4
Porta Agujas .....	39-45
Porta Agujas de TC .....	44, 45
Porta Cubetas Rodables .....	143
Porta Esponjas .....	36, 37, 38
Porta Termómetros .....	140
POTTS-SMITH Pinza de Disección .....	47
POTTS-SMITH Tijeras para Operaciones .....	17
PRATT Especulo .....	109
PRATT Pinza Intestinal .....	52
Productos Para Cuidado de Pacientes y Laboratorio .....	132-149

## R

RAMPLEY Pinza Porta-Esponjas .....	37
RANDALL Cánula Uterina .....	93
RANDALL Pinza para Calculos Biliares .....	104
RECAMIER Cureta Uterina .....	101
Retractors de Cachete .....	5
Retractors de Hojas .....	85
Retractors Labial .....	5
Retractors Universal .....	97
Retractors Vaginal .....	96
RICHARDSON Separador .....	73
RICHARDSON-EASTMAN Separador .....	73
ROCHESTER-OCHSNER Pinza Hemostática.....	30
ROCHESTER-PEAN Pinza Hemostática .....	29
ROEDER Pinza de Campo.....	35

ROGER Tijeras para Cable de TC .....	26
ROGER Tijeras Para Vendaje .....	20
RUSA Pinza Quirúrgicas .....	48

## S

SAROT (CRAFOORD) Pinza Arterial Torácica .....	84
SAROT Porta Agujas .....	40
SATERLEE Sierra de Hueso .....	111
SATINSKY-DEBAKEY Pinza para Vena Cava .....	83
SAWTELL Instrumental Tonsila .....	54
SCHROEDER (POZZI) Pinza Uterina .....	90
SEMKEN Pinza de Disección .....	48
SEMKEN Pinza Quirúrgicas .....	48
SENN (MILLER) Separador .....	70
Separador Abdominal .....	71, 72, 76, 77
Separador Maleable de Ribbon .....	70
Separador Vaginal .....	95
Separadores Generales .....	64-78
Set de Diagnóstico, Oído, Nariz y Garganta .....	125
Sets de Instrumentos .....	150-156
Sierra de Hueso Punta redonda .....	111
Sierras Para Hueso Y Mango Con Sierras .....	110, 111
SIMPSON Pinza Obstetrica .....	105
SIMPSON-LUIKART Pinza Obstetrica .....	106
SIMS Cureta Uterina .....	100
SIMS Especulo .....	109
SIMS Especulo Vaginal .....	94
SIMS Histerómetro Uterino .....	92
SINGLEY Pinza Intestinal .....	52
SOMER Pinza Uterina .....	97
Sondas Acanaladas Y Estiletes .....	53
SPENCER Tijeras para Vendaje .....	20
STEVENS Tijeras de Tenotomía .....	15

## T

Tambores Verticales para Esterilización con Ventilación .....	146
Tapas Cilíndricas .....	148
TAYLOR Diapasón y Martillo Neurológico .....	59
TAYLOR Martillos .....	1
Taza con Tapa .....	148
THOMAS-ALLIS Pinza Intestinal con Dientes .....	50
Tijeras Con Hojas de TC .....	23-26
Tijeras Cordon Umbilical .....	16
Tijeras de Disección .....	11, 12
Tijeras de Disección de TC .....	25, 26



## INDEX ALFABÉTICO

Tijeras de Episiotomía .....	16
Tijeras Iris .....	24
Tijeras para Cable .....	20
Tijeras para Empasto .....	22
Tijeras Para Emplasto .....	22
Tijeras Para Operaciones .....	9, 17
Tijeras para Quitar Puntos.....	20
Tijeras Para Vendajes .....	18-21
Tijeras Quirúrgicas .....	9, 10
Tijeras Quirúrgicas de TC .....	23
Tijeras Utility .....	19
Torunderos con Tapas y Agarradera .....	143
Tubos de Aspiracion .....	63
TUFFIER Retractor .....	85
TYDING Snare Instrumental Tonsila .....	7, 54

### U

U.S. ARMY Separador .....	65
UNIVERSIDAD DE MINNESOTA Retractor .....	5
USA Tijeras para Cordon Umbilical .....	16
UTILITY Tijeras para Vendajes .....	19

### V

Vasos Graduados .....	142
Vasos Metalicos .....	135
VIENNA Espéculo Nasal .....	61
VOLKMAN Separador con Garras .....	77

### W

WALLICH Cureta para aborto o Placenta .....	100
WARTENBERG Sensimetro .....	2
WEBSTER Porta Agujas .....	39
WEBSTER Porta Agujas de TC .....	44
WEIDER Depresor de Lengua .....	5
WEITLANER Separadores .....	66
WESTCOTT Tijeras para Vendaje .....	21

### Y

YANKAUER Cánula Aspiradora .....	4
Yodero .....	141



**MASTERMED**  
MASTERS EN PRODUCTOS MÉDICOS